



Standard and
emergency escape
sliding door
systems with
ES operators

DORMA

ST/ES

TST

For every entrance, every application, every requirement

Automatic sliding and telescopic sliding door systems from DORMA are available in a wide selection of models and designs to ensure optimum tailoring to different structural situations, openings and individual demands. Whatever the specification

remit – functionality, motion sequences, visual appearance, stability, thermal insulation or anti-intruder protection – ST/ES, FST/ES, TST and FTST door systems can be relied upon not only to satisfy it in full but also to set new standards along the way.

High-performance ES operators

DORMA door operators are characterised by their fast, smooth operation, low noise and high level of user convenience. The ES drive units with which the door

systems described here are equipped offer plenty of power plus the guarantee of high functional reliability even under difficult operating conditions.

For emergency exits and escape routes

All models of these DORMA sliding door systems are equipped with a redundant drive unit, auxiliary safety control and a self-monitoring radar motion detector. The additional 'F' in their type

designation indicates that they have been type-approved as an automatic sliding door without breakout for use in emergency exits and escape routes.



Truly cost-efficient

Due to a large number of standard dimensions, automatic sliding and telescopic sliding door systems from DORMA guarantee the implementation of truly cost-efficient solutions.

All the systems are made to measure and supplied ready to fit. If required, DORMA will also perform the installation and commissioning work.

Convenient and safe

As microprocessor systems, the controls with their adjustable parameters and self-learning capabilities meet every conceivable requirement relating to functional scope. At the same time, they offer a guarantee for high reliability and, together with the closing force monitoring system, ensure maximum operational safety. Integrated locks enable individual security requirements to be fully accommodated.

Large clear passage width

With automatic telescopic sliding door systems, particularly large clear passage widths can be applied. As the door leaves consist of two sections, in the open condition they only require around one third of the structural width available for the door system.

Features and benefits

- Unbeatable performance
- Problem-free adaptability to individual requirements
- Emergency exit and escape route doors provided with a redundant drive unit, an auxiliary safety control unit and a self-monitoring radar motion detector
- Good cost-efficiency and reliability due to proven components and quality-assured manufacture
- Numerous adjustable parameters
- Comprehensive range of connections provided as standard
- Automatic obstruction detection and reversing cycle
- Delivered ready to fit, with installation and commissioning also available on request
- Designed and manufactured in accordance with the latest state of the art and in line with all relevant standards and specifications
- Optional, individually tailored anti-intruder protection



Contents	Page
Types, dimensions, data and functions	4
Sliding doors with fine frame profiles DORMA ST-G/ES, FST-G/ES	6
Sliding doors with fine frame double-glazing profiles DORMA ST-G-Iso/ES, FST-G-Iso/ES	8
Sliding doors with standard frame profiles DORMA ST-R/ES, FST-R/ES	10
Sliding doors with thermal break profiles DORMA ST-R-Thermo/ES, FST-R-Thermo/ES	12
Telescopic sliding doors with fine frame profiles DORMA TST-G, FTST-G	14
Telescopic sliding doors with fine frame double glazing profiles DORMA TST-G-Iso, FTST-G-Iso	16
Telescopic sliding doors with standard frame profiles DORMA TST-R, FTST-R	18
Sliding doors with concealed-rod locking DORMA ST-R/ES, ST-G-Iso/ES	20
Operator models DORMA ES, ES E, ES T, ES TE	24
Accessories	26
Specification text, DORMA TST, FTST	27
Specification text, DORMA ST/ES, FST/ES	28



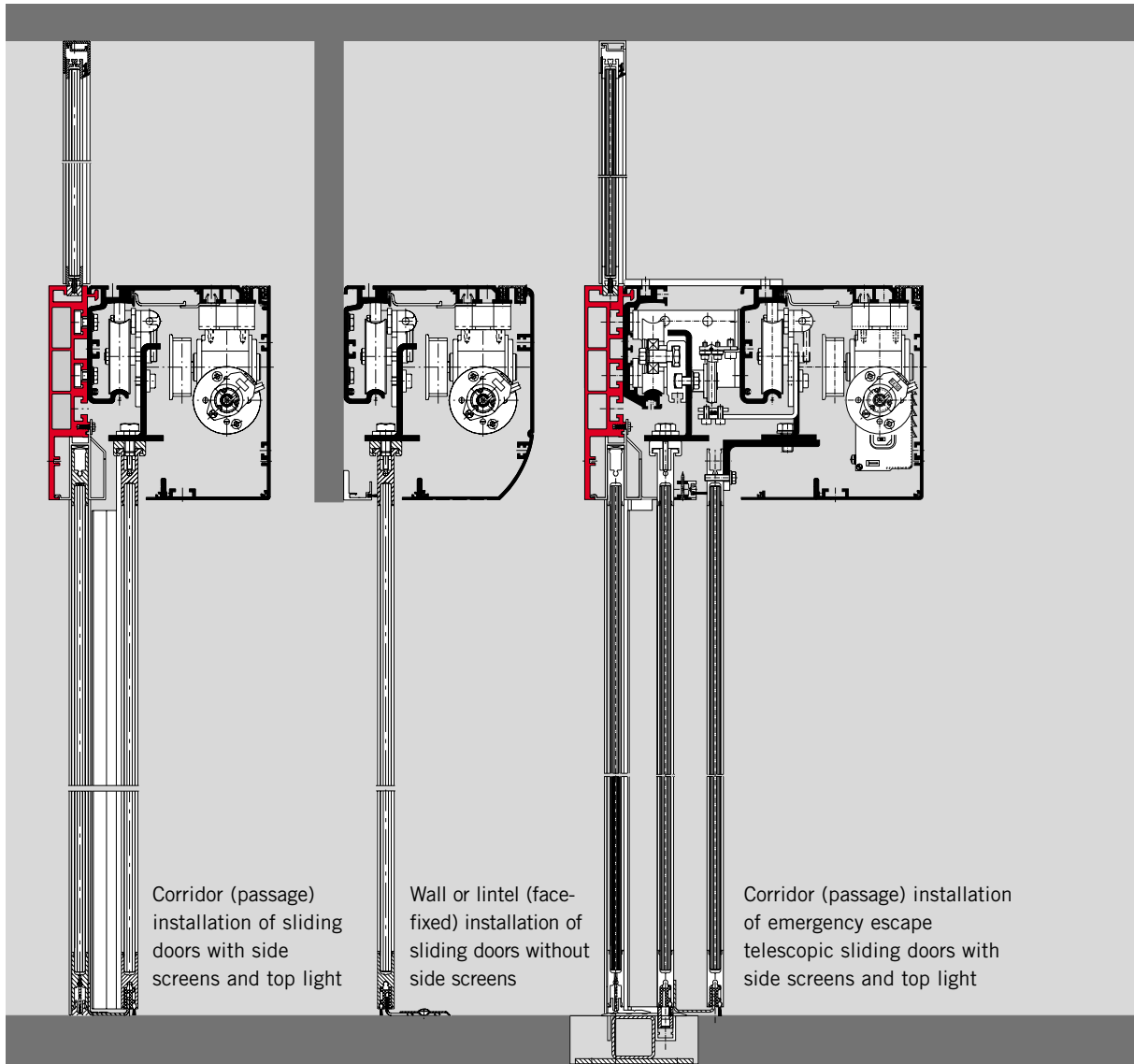

DORMA ST/ES, FST/ES

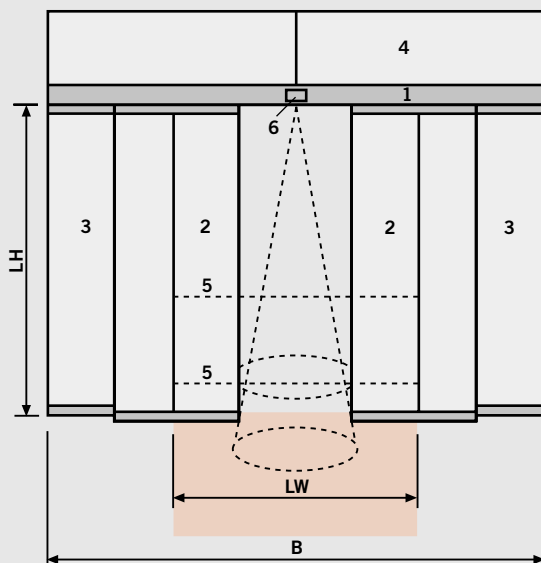

Dimensions and designs		ST/ES	FST/ES	TST	FTST
Operator type					
Standard	ES 90	■	■	–	–
Standard with increased motor capacity	ES 90 E	■	■	–	–
Enhanced	ES 100	■	■	–	–
Enhanced with increased motor capacity	ES 100 E	■	■	–	–
Standard telescopic operator	ES 90 T	–	–	■	■
Standard telescopic with increased motor capacity	ES 90 TE	–	–	■	■
Single-sided sliding and telescopic sliding door system					
Number of door leaves		1	1	2	2
Right-handed opening action		■	■	■	■
Left-handed opening action		■	■	■	■
Opening width	ES 90	700 – 2000 mm	1000 – 1400 mm	–	–
	ES 90 E	700 – 2000 mm	1000 – 1400 mm	–	–
	ES 100	700 – 2000 mm	1000 – 1400 mm	–	–
	ES 100 E	700 – 2000 mm	1000 – 1400 mm	–	–
	ES 90 T	–	–	800 – 1400 mm	900 – 1400 mm
	ES 90 TE	–	–	1400 – 2600 mm	1400 – 2400 mm
Door leaf weight, max.	ES 90	1 x 200 kg	1 x 100 kg	–	–
	ES 90 E	1 x 200 kg	1 x 100 kg	–	–
	ES 100	1 x 200 kg	1 x 100 kg	–	–
	ES 100 E	1 x 200 kg	1 x 100 kg	–	–
	ES 90 T	–	–	2 x 50 kg	2 x 50 kg
	ES 90 TE	–	–	2 x 50 kg	2 x 50 kg
Double-sided sliding and telescopic sliding door system					
Number of door leaves		2	2	4	4
Opening width	ES 90	800 – 3000 mm	1000 – 2200 mm	–	–
	ES 90 E	800 – 3000 mm	1000 – 2500 mm	–	–
	ES 100	800 – 3000 mm	1000 – 2200 mm	–	–
	ES 100 E	800 – 3000 mm	1000 – 2500 mm	–	–
	ES 90 T	–	–	1400 – 2000 mm	1400 – 2000 mm
(max. emergency escape width 2500 mm)	ES 90 TE	–	–	1800 – 4000 mm	1400 – 3000 mm
Door leaf weight max.	ES 90	2 x 100 kg	2 x	75 kg	– –
	ES 90 E	2 x 130 kg	2 x	100 kg	– –
	ES 100	2 x 100 kg	2 x	75 kg	– –
	ES 100 E	2 x 150 kg	2 x	100 kg	– –
	ES 90 T	–	–	4 x 38 kg	4 x 38 kg
	ES 90 TE	–	–	4 x 50 kg	4 x 50 kg
Operator cross section, width x height (with square-edged cover)	ES 90 G	171 x 200	171 x 200	280 x 200	280 x 200
	ES 100 G-Iso	171 x 200	171 x 200	280 x 200	280 x 200
	ES 100 R	202 x 200	202 x 200	280 x 200	280 x 200
	ES 100 R-Thermo	202 x 200	202 x 200	280 x 200	280 x 200
	ES 90 E G	202 x 200	202 x 200	311,5 x 200	311,5 x 200
	ES 100 E G-Iso	202 x 200	202 x 200	311,5 x 200	311,5 x 200
	ES 100 E R	202 x 200	202 x 200	311,5 x 200	311,5 x 200
	ES 100 E R-Thermo	202 x 200	202 x 200	311,5 x 200	311,5 x 200
Clear passage height LH		2100 – 3000 mm	2100 – 3000 mm	2100 – 2500 mm	2100 – 2500 mm
Fixed side screens		○	○	○	○
Safety distance at secondary closing edges		○	○	○	○
Hinged safety pocket screens (model ST-G/ES only)		○	○	–	–
Software for protection at the secondary closing edges		○	○	○	○
Sliding leaf and side screen design					
– Fine frame (toughened glass) profiles G		■	■	■	■
– Double glazing profiles G-Iso		■	■	■	■
– Standard frame profiles R		■	■	■	■
– Thermal break profiles R-Thermo		■	■	–	–
Top light		○	○	○	○
Solid top panel		○	○	○	○
Operator height		200 mm	200 mm	200 mm	200 mm
Low-noise track rail for ES 90 and ES 90 E		●	●	●	●
Low-noise track rail for ES 100 and ES 100 E		●	●	–	–

Operator drive and control unit	ST/ES TST	FST/ES FTST
Operator type		
Expansion modules	EM 4	EM 5
Short-circuit-proof switched power supply unit		●
Microprocessor control		●
Function programs		
– Off		●
– Automatic		●
– Permanent open		●
– Partial opening or self-regulating partial opening		●
– Exit only		●
– Exit only, partial opening		●
– Night-bank control		●
Connection for airlock control	○	–
Pharmacy control	○	–
Delayed opening action for cheque card/code card reader or key switch		○
Self-learning		●
Light barriers, self-monitoring (two pairs)		●
Automatic reversal		●
Fail-safe (opens when de-energised)	■	●
Fail-secure (closes when de-energised)	■	–
Emergency closing feature (ensure compliance with local regulations)	○	○
Program selector CP 90 or CP 90C	○	–
Connection for access control system		●
Bell contact		●
Door status signal		○
Module for connection to EIB building control system		○

Ancillary equipment	ST/ES	FST/ES	TST	FTST
Locking system				
– Electro-mechanical locking (dual-action hook lock) with manual unlocking	○	–	○	–
– Automatic concealed-rod multipoint locking (only with R and G-Iso frame profiles)	○	○	–	–
– Floor lock	○	○*	○	○*
– Hook bolt lock (only with R frame profiles)	○	○*	○	○*
Visual fault indicator	○	●	○	●
Battery pack	●	●	●	●
Emergency power module (UPS)	○	○	○	○

*The emergency escape function can be disabled by activating the lock. This may only be performed by a properly authorised person.

Technical data	ST, TST	FST, FTST
Adjustable opening and closing force, max. 150 N		●
Parameter adjustment		●
Adjustable opening speed		
– ES 90, ES 100, ES 90 T operator	100 – 600 mm/s	
– ES 90 E, ES 100 E, ES 90 TE operator	100 – 750 mm/s	
Adjustable closing speed	100 – 550 mm/s	
Adjustable creep speed	30 – 90 mm/s	
Adjustable hold-open time	0 – 180 s	
Power supply data	230 V, 50/60 Hz	
Power consumption, max.	360 W	
Power consumption, average	30 W	
Outgoing power supply	24 V, 2 A	
Degree of protection	IP 20	
Type-approved by German Technical Inspectorate (TÜV)		●
Tested and approved in accordance with EU low voltage directives		●
Quality-assured manufacture to ISO 9000		●

● Standard ■ Option ○ Accessory

DORMA FST/ES, FTST connections

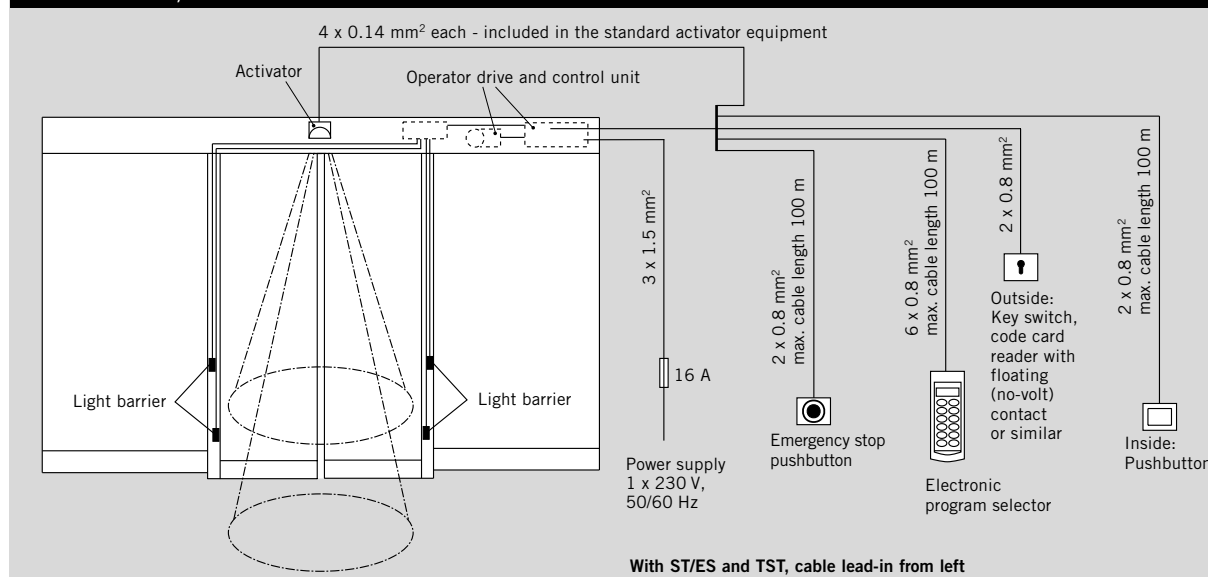

With G-type fine frame profiles

Features

- Elegant all-glass appearance due to slender frame profiles
- High stability and rigidity
- Protection against draughts by side seals

1 With LM (aluminium) girder, top light and side screens

2 Lintel fixing (not illustrated)

3 Floor guide

Operator

ES 90 or ES 90 E as required or as dictated by leaf weights – see page 24

System height

$H = LH + \text{min. } 200 \text{ mm}$



FST-G/ES

Determining the leaf size:

Dependent on clear passage height **LH** and clear passage width **LW**. Do not exceed the maximum door leaf weight allowed for the operators (drive units) concerned. For difficult wind conditions adjust size of door.

ST-G/ES

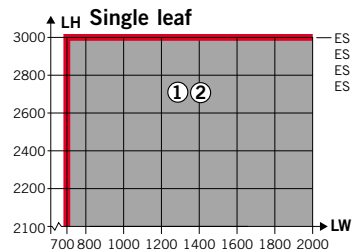

Glazing

- ① Toughened safety glass (TSG) 10 mm
- ② Laminated safety glass (LSG) 2 x 5 mm

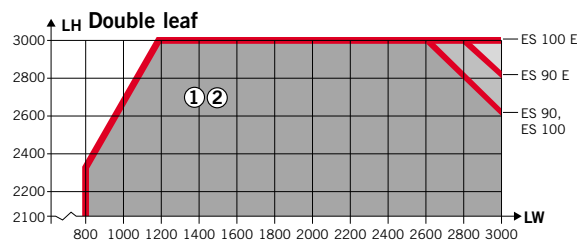

FST-G/ES

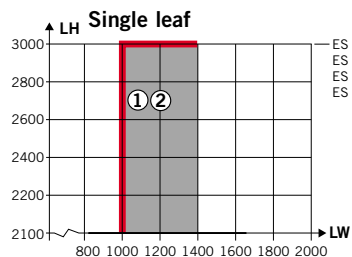

Glazing

- ① Toughened safety glass (TSG) 10 mm
- ② Laminated safety glass (LSG) 2 x 5 mm

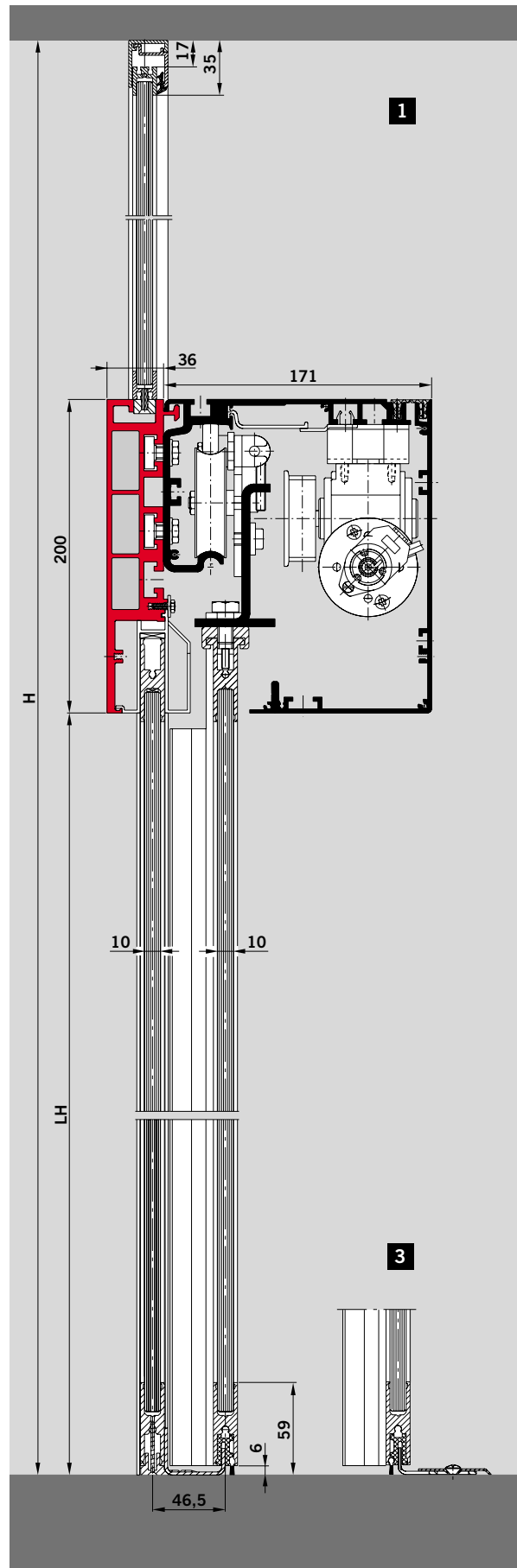
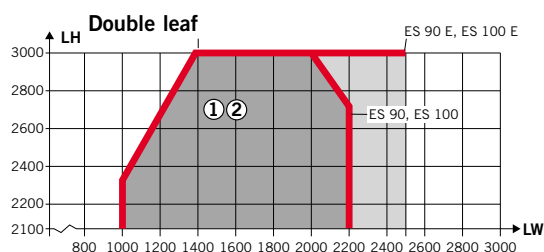

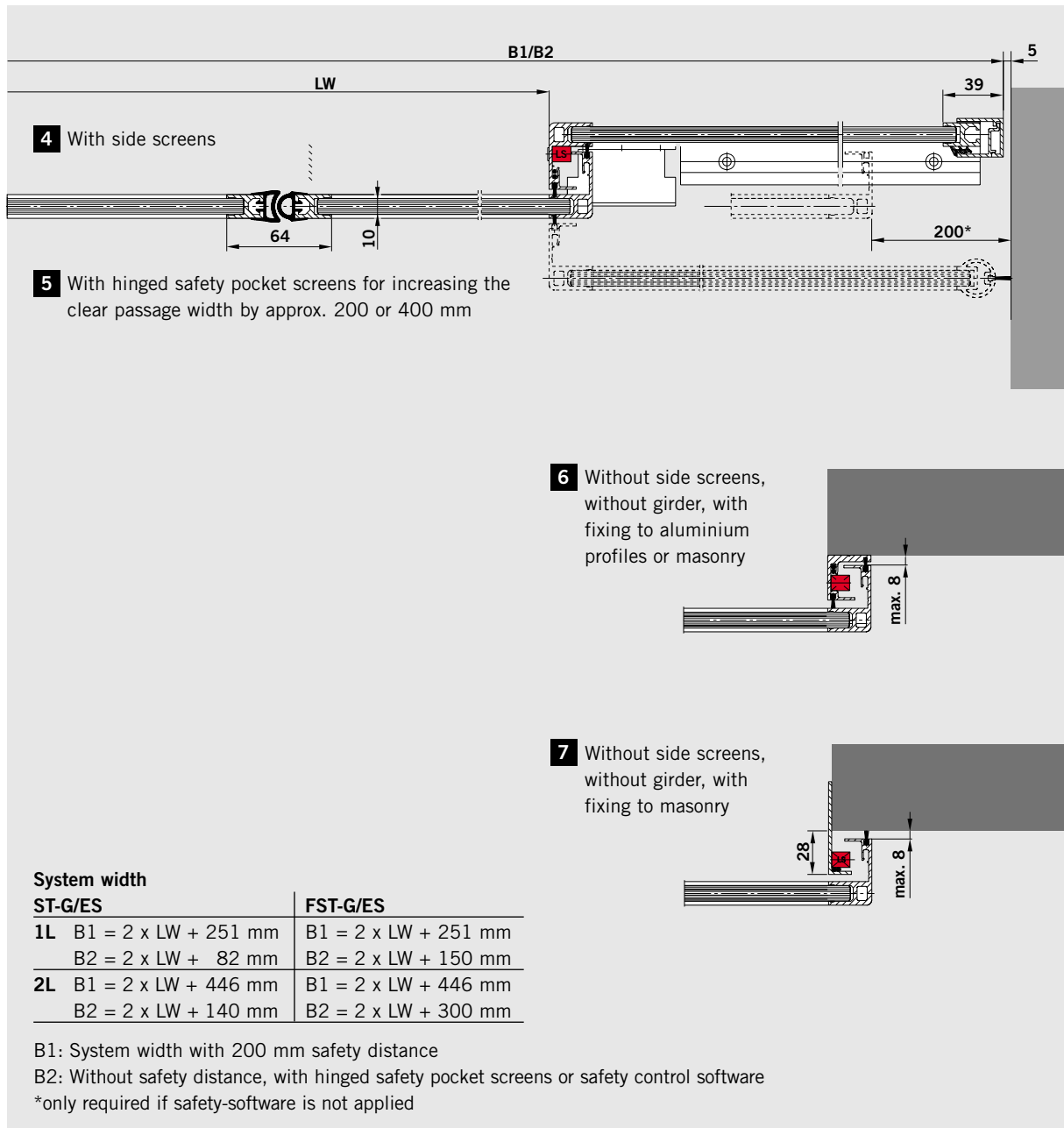

Standard clear passage widths and system widths

Version		-2	-1	0	1	2	3	4	5	6	7	8	9	10	11	12	13	14	15	16	17	18	19	20	21	
LW		700	800	900	1000	1100	1200	1300	1400	1500	1600	1700	1800	1900	2000	2100	2200	2300	2400	2500	2600	2700	2800	2900	3000	
DORMA ST-G/ES																										
1L	B1	1651	1851	2051	2251	2451	2651	2851	3051	3251	3451	3651	3851	4951	4251											
1L	B2	1482	1682	1882	2082	2282	2482	2682	2882	3082	3282	3482	3682	3882	4082											
2L	B1				2446	2646	2846	3046	3246	3446	3646	3846	4046	4246	4446	4646	4846	5046	5246	5446	5646	5846	6046	6246	6446	
2L	B2				2140	2340	2540	2740	2940	3140	3340	3540	3740	3940	4140	4340	4540	4740	4940	5140	5340	5540	5740	5940	6140	
DORMA FST-G/ES																										
1L	B1	1651	1851	2051	2251	2451	2651	2851	3051																	
1L	B2	1550	1750	1950	2150	2350	2550	2750	2950																	
2L	B1				2446	2646	2846	3046	3246	3446	3646	3846	4046	4246	4446	4646	4846	5046	5246	5446						
2L	B2				2300	2500	2700	2900	3100	3300	3500	3700	3900	4100	4300	4500	4700	4900	5100	5300						

With G-Iso double glazing fine frame profiles

Features

- Elegant all-glass appearance due to slender frame profiles
- High stability and rigidity
- Low k value with double glazing
- Particularly good insulating properties due to interlocking side seals plus top and bottom seals

System height

$$H = LH + \text{min. } 200 \text{ mm}$$

1 With LM (aluminium) girder, top light and side screens

2 Lintel fixing (not illustrated)

3 Floor guide

Operator

ES 90 or ES 90 E as required or as dictated by leaf weights
- see page 24



FST-G-Iso/ES

Determining the leaf size:

Dependent on clear passage height **LH** and clear passage width **LW**. Do not exceed the maximum door leaf weight allowed for the operators (drive units) concerned. For difficult wind conditions adjust size of door.

ST-G-Iso/ES

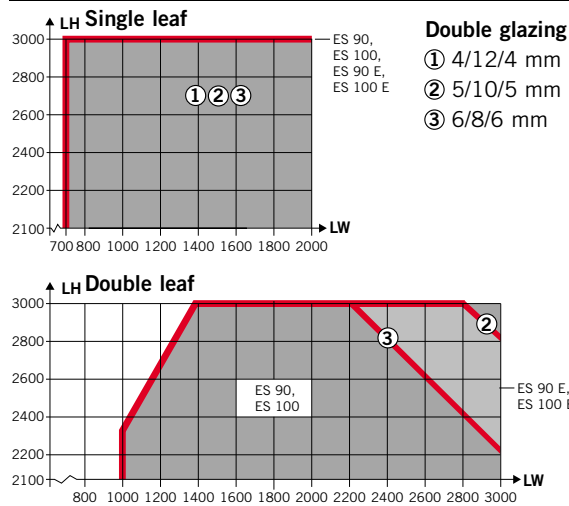

FST-G-Iso/ES

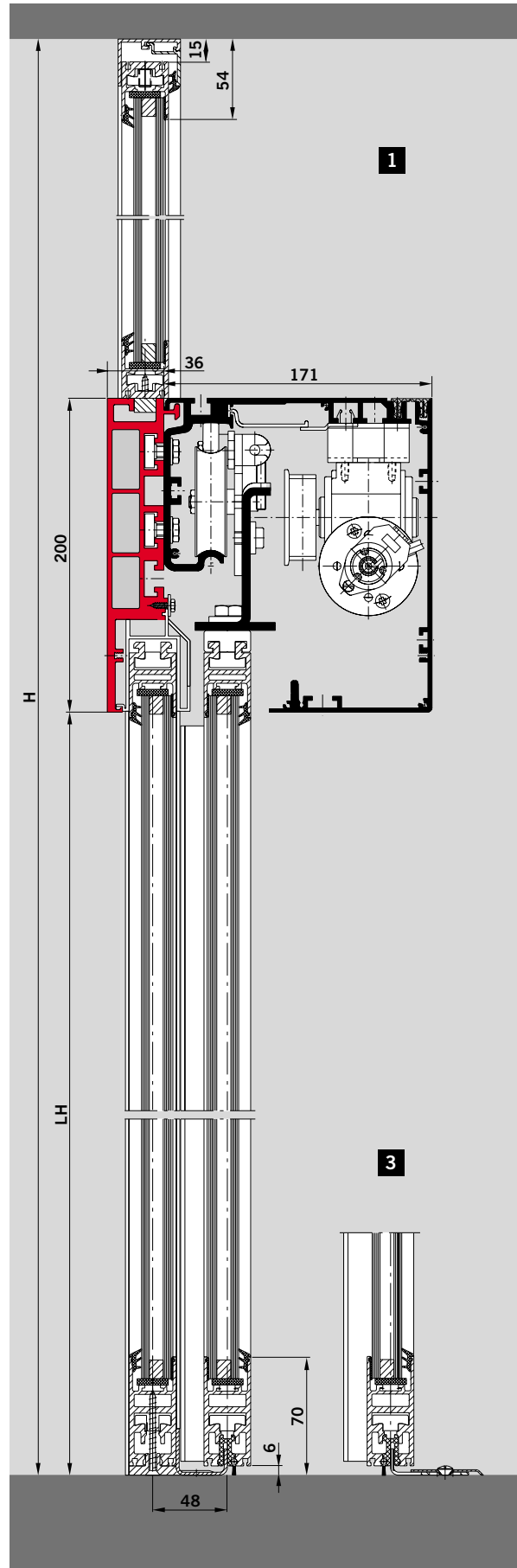
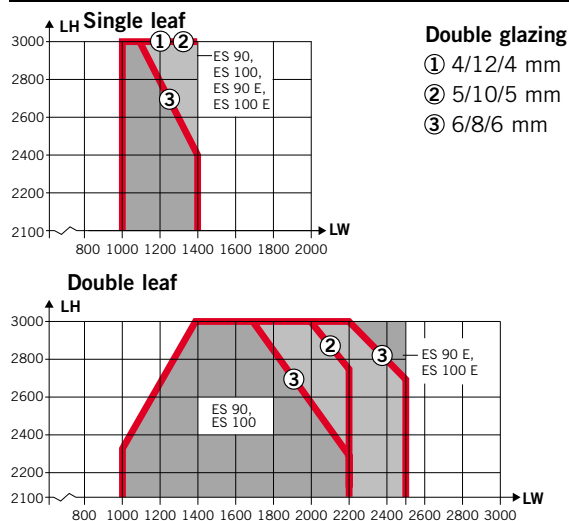

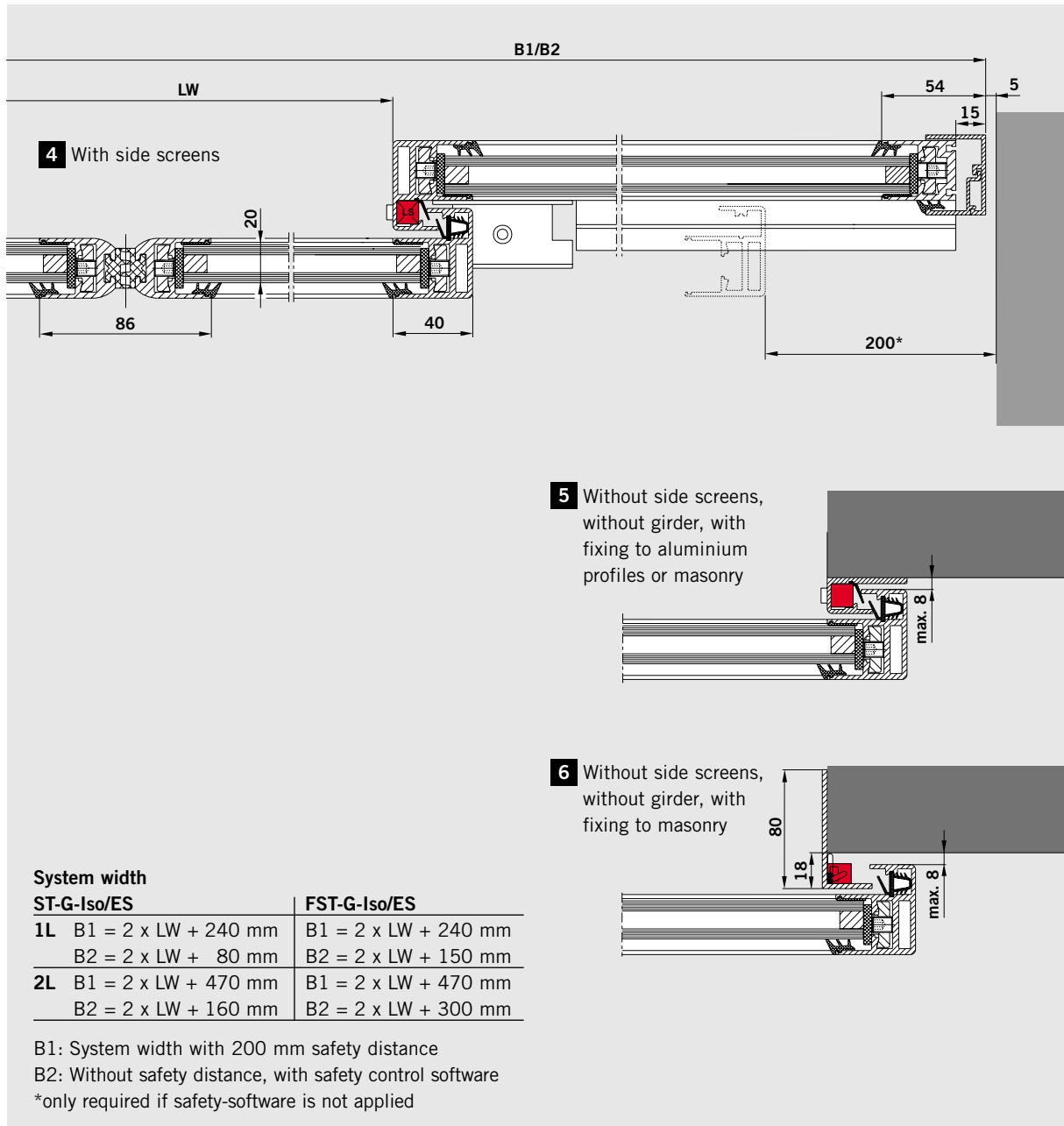

Standard clear passage widths and system widths

Version		-2	-1	0	1	2	3	4	5	6	7	8	9	10	11	12	13	14	15	16	17	18	19	20	21	
LW		700	800	900	1000	1100	1200	1300	1400	1500	1600	1700	1800	1900	2000	2100	2200	2300	2400	2500	2600	2700	2800	2900	3000	
DORMA ST-G-Iso/ES																										
1L	B1	1640	1840	2040	2240	2440	2640	2840	3040	3240	3440	3640	3840	4040	4240											
1L	B2	1480	1680	1880	2080	2280	2480	2680	2880	3080	3280	3480	3680	3880	4080											
2L	B1				2470	2670	2870	3070	3270	3470	3670	3870	4070	4270	4470	4670	4870	5070	5270	5470	5670	5870	6070	6270	6470	
2L	B2				2160	2360	2560	2760	2960	3160	3360	3560	3760	3960	4160	4360	4560	4760	4960	5160	5360	5560	5760	5960	6160	
DORMA FST-G-Iso/ES																										
1L	B1	1640	1840	2040	2240	2440	2640	2840	3040																	
1L	B2	1550	1750	1950	2150	2350	2550	2750	2950																	
2L	B1				2470	2670	2870	3070	3270	3470	3670	3870	4070	4270	4470	4670	4870	5070	5270	5470						
2L	B2				2300	2500	2700	2900	3100	3300	3500	3700	3900	4100	4300	4500	4700	4900	5100	5300						

With R-type standard frame profiles

Features

- Rugged frames which reliably protect the glazing
- High stability and rigidity
- Protection against draughts due to interlocking side seals

Operator

ES 90 or ES 90 E as required or as dictated by leaf weights – see page 24

System height

$$H = LH + \text{min. } 200 \text{ mm}$$

1 With LM (aluminium) girder, top light and side screens, or with MSH steel hollow section girder (not illustrated)

2 Lintel fixing (not illustrated)

3 Floor guide



Determining the leaf size:

Dependent on clear passage height **LH** and clear passage width **LW**. Do not exceed the maximum door leaf weight allowed for the operators (drive units) concerned. For difficult wind conditions adjust size of door.

ST-R/ES

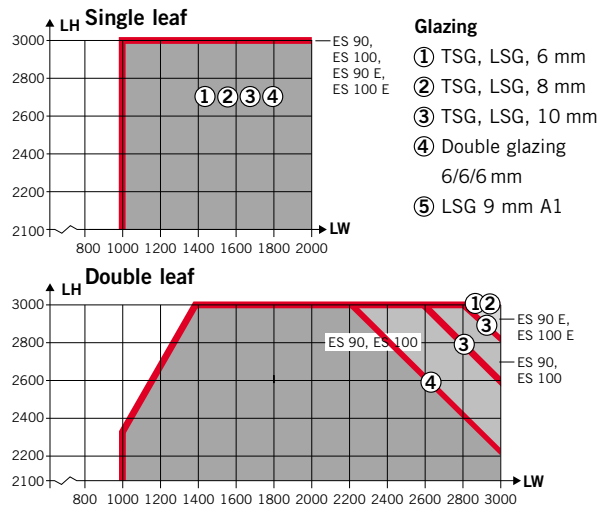

FST-R/ES

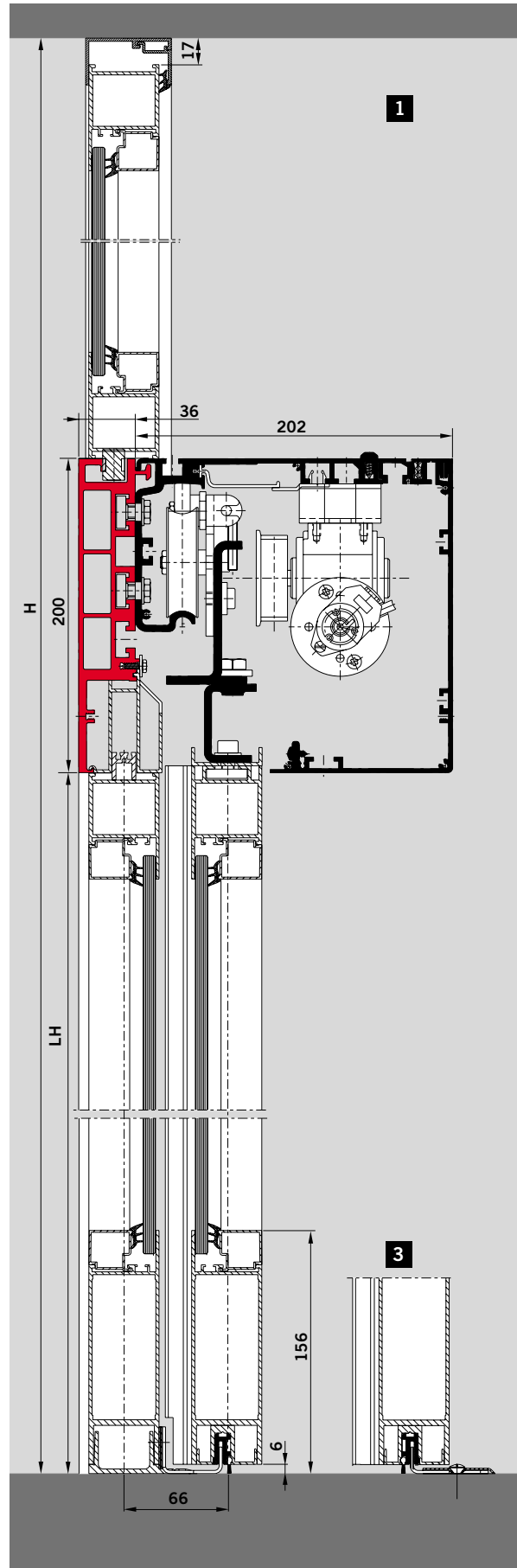
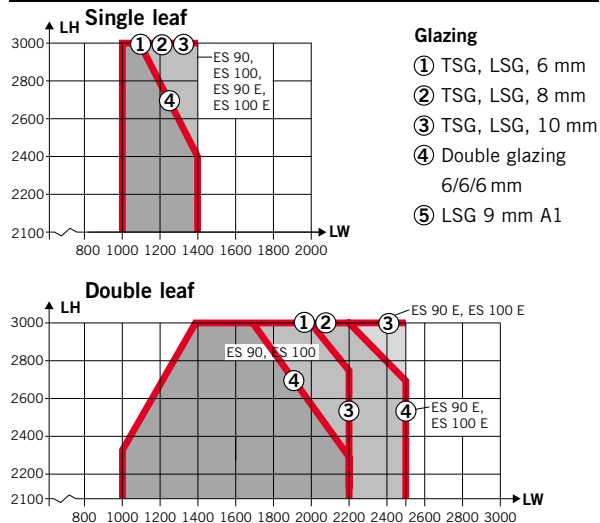

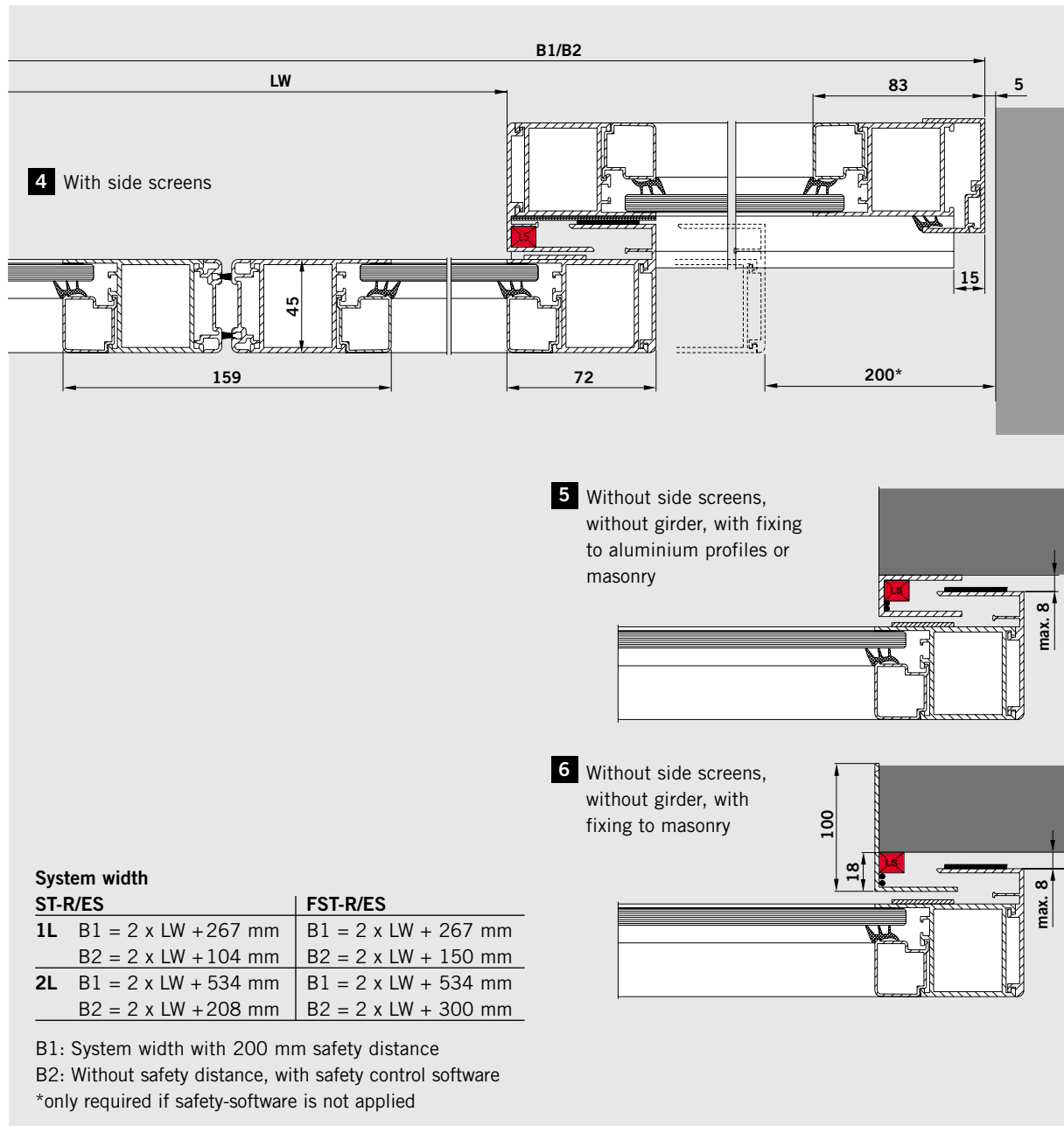

Standard clear passage widths and system widths

Version		-2	-1	0	1	2	3	4	5	6	7	8	9	10	11	12	13	14	15	16	17	18	19	20	21	
LW		700	800	900	1000	1100	1200	1300	1400	1500	1600	1700	1800	1900	2000	2100	2200	2300	2400	2500	2600	2700	2800	2900	3000	
DORMA ST-R/ES																										
1L	B1	1667	1867	2067	2267	2467	2667	2867	3067	3267	3467	3667	3867	4067	4267											
1L	B2	1504	1704	1904	2104	2304	2504	2704	2904	3104	3304	3504	3704	3904	4104											
2L	B1				2534	2734	2934	3134	3334	3534	3734	3934	4134	4334	4534	4734	4934	5134	5334	5534	5734	5934	6134	6334	6534	
2L	B2				2208	2408	2608	2808	3008	3208	3408	3608	3808	4008	4208	4408	4608	4808	5008	5208	5408	5608	5808	6008	6208	
DORMA FST-R/ES																										
1L	B1	1667	1867	2067	2267	2467	2667	2867	3067																	
1L	B2	1550	1750	1950	2150	2350	2550	2750	2950																	
2L	B1				2534	2734	2934	3134	3334	3534	3734	3934	4134	4334	4534	4734	4934	5134	5334	5534						
2L	B2				2300	2500	2700	2900	3100	3300	3500	3700	3900	4100	4300	4500	4700	4900	5100	5300						

With R-Thermo thermal break profiles

Features

- Rugged frames which reliably protect the glazing
- High stability and rigidity
- Low system k value due to full thermal break in frame and double glazing
- Particularly good insulating properties due to interlocking side seals plus top and bottom seals

Operator

ES 90 or ES 90 E as required or as dictated by leaf weights
- see page 24

System height

$H = LH + \text{min. } 200 \text{ mm}$

1 With LM (aluminium) girder, top light and side screens

2 Lintel fixing (not illustrated)

 FST-R-Thermo/ES

Determining the leaf size:

Dependent on clear passage height **LH** and clear passage width **LW**. Do not exceed the maximum door leaf weight allowed for the operators (drive units) concerned. For difficult wind conditions adjust size of door.

ST-R-Thermo/ES

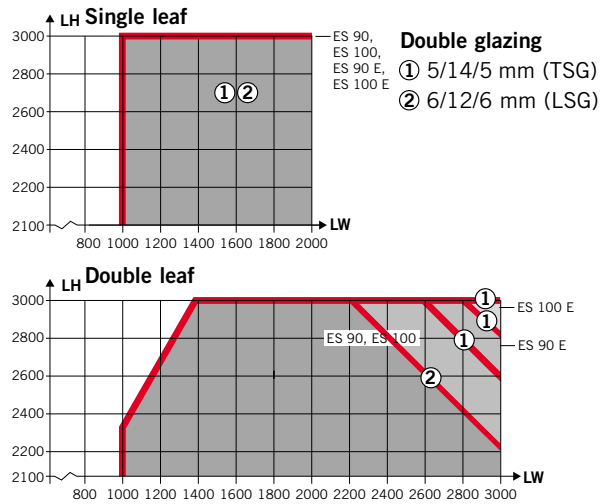

FST-R-Thermo/ES

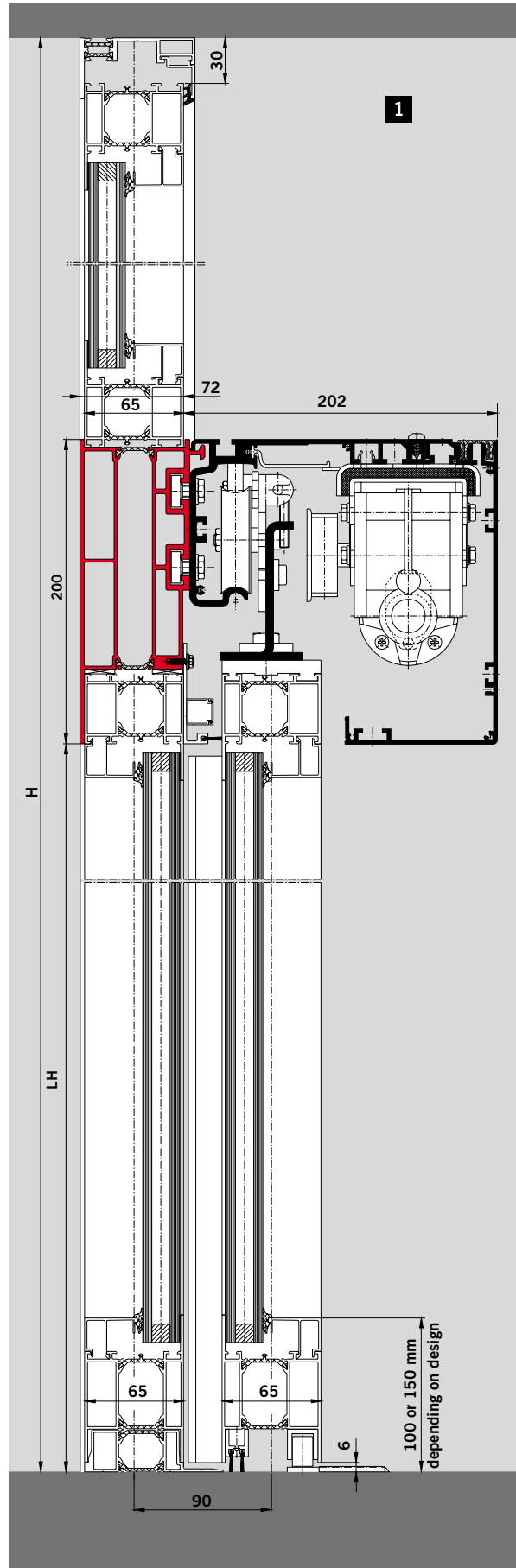
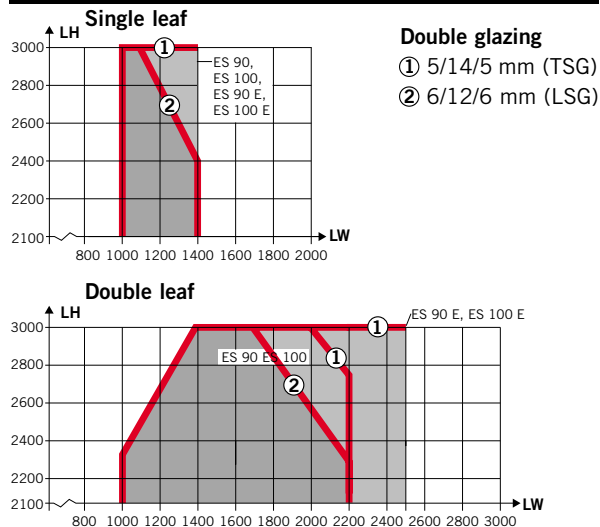

3 With side screens

4 Without side screens, without girder, with fixing to aluminium profiles or masonry

5 Without side screens, without girder, with fixing to masonry

System width

	ST-R-Thermo/ES	FST-R-Thermo/ES
1L	B1 = 2 x LW + 272 mm B2 = 2 x LW + 122 mm	B1 = 2 x LW + 272 mm B2 = 2 x LW + 150 mm
2L	B1 = 2 x LW + 544 mm B2 = 2 x LW + 244 mm	B1 = 2 x LW + 544 mm B2 = 2 x LW + 300 mm

B1: System width with 200 mm safety distance
 B2: Without safety distance, with safety control software
 *only required if safety-software is not applied

Illustration shows "Heroal 065" profile series

Standard clear passage widths and system widths

Version		-2	-1	0	1	2	3	4	5	6	7	8	9	10	11	12	13	14	15	16	17	18	19	20	21	
LW		700	800	900	1000	1100	1200	1300	1400	1500	1600	1700	1800	1900	2000	2100	2200	2300	2400	2500	2600	2700	2800	2900	3000	
DORMA ST-R-Thermo/ES																										
1L	B1	1672	1872	2072	2272	2472	2672	2872	3072	3272	3472	3672	3872	4072	4272											
1L	B2	1522	1722	1922	2122	2322	2522	2722	2922	3122	3322	3522	3722	3922	4122											
2L	B1				2544	2744	2944	3144	3344	3544	3744	3944	4144	4344	4544	4744	4944	5144	5344	5544	5744	5944	6144	6344	6544	
2L	B2				2244	2444	2644	2844	3044	3244	3444	3644	3844	4044	4244	4444	4644	4844	5044	5244	5444	5644	5844	6044	6244	
DORMA FST-R-Thermo/ES																										
1L	B1	1672	1872	2072	2272	2472	2672	2872	3072																	
1L	B2	1550	1750	1950	2150	2350	2550	2750	2950																	
2L	B1				2544	2744	2944	3144	3344	3544	3744	3944	4144	4344	4544	4744	4944	5144	5344	5544						
2L	B2				2300	2500	2700	2900	3100	3300	3500	3700	3900	4100	4300	4500	4700	4900	5100	5300						

With G-type fine frame profiles

Features

- Elegant all-glass appearance due to slender frame profiles
- High stability and rigidity
- Protection against draughts by side seals
- Large clear passage width

- 1 With LM (aluminium) girder, top light and side screens
- 2 Lintel fixing (not illustrated)
- 3 Floor guide without side screen

Operator

ES 90 T or ES 90 TE as required or as dictated by leaf weights

System height

$H = LH + \text{min. } 200 \text{ mm}$



FTST-G

Determining the leaf size:

Dependent on clear passage height **LH** and clear passage width **LW**. Do not exceed the maximum door leaf weight allowed for the operators (drive units) concerned. For difficult wind conditions adjust size of door.

TST-G

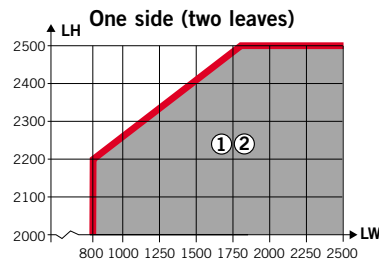

Glazing

- 1 TSG 10 mm
- 2 LSG 2 x 5 mm

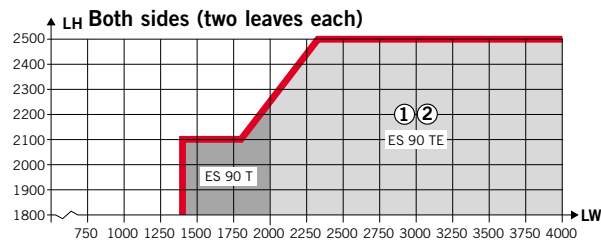

FTST-G

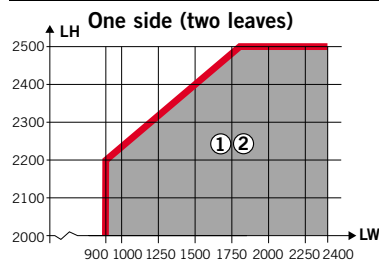

Glazing

- 1 TSG 10 mm
- 2 LSG 2 x 5 mm

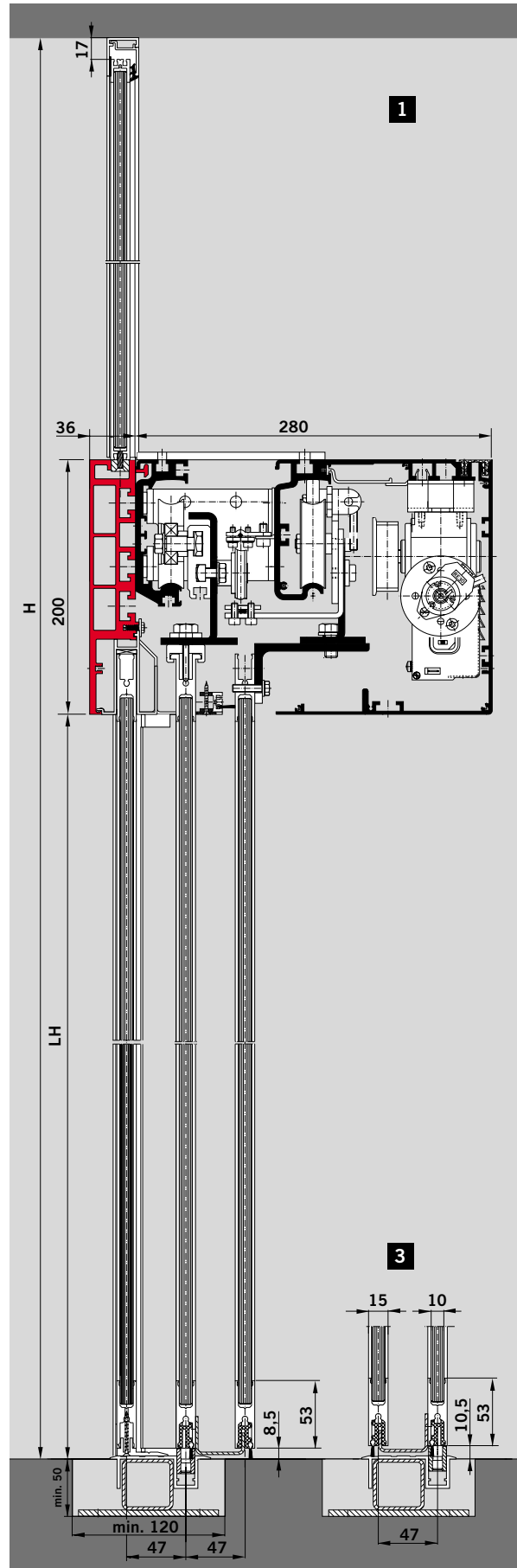
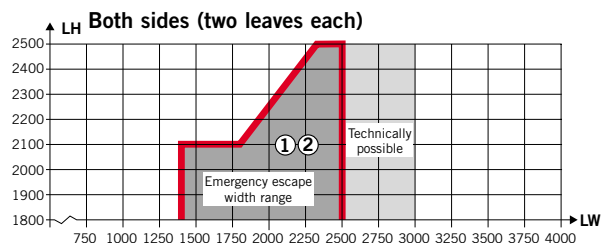

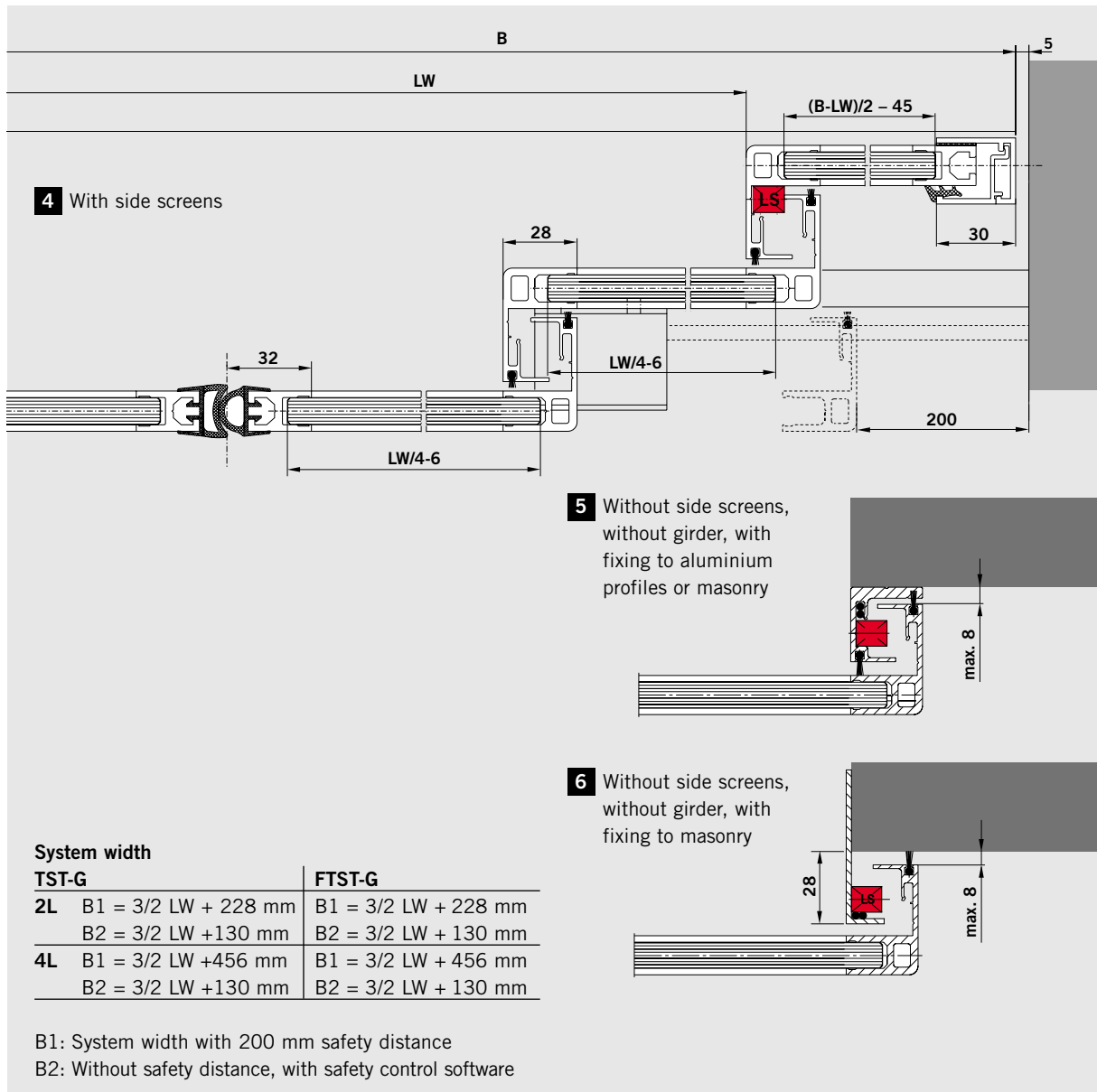

Standard clear passage widths and system widths

Version		1	2	3	4	5	6	7	8	9	10	11	12	13	14	15	16	17	18	19	20	21	22	23	33	
LW		800	900	1000	1100	1200	1300	1400	1500	1600	1700	1800	1900	2000	2100	2200	2300	2400	2500	2600	2700	2800	2900	3000	4000	
DORMA TST-G																										
2L	B1	1428	1578	1728	1878	2028	2178	2328	2478	2628	2778	2928	3078	3228	3378	3528	3678	3828	3978							
2L	B2	1330	1480	1630	1780	1930	2080	2230	2380	2530	2680	2830	2980	3130	3280	3430	3580	3730	3880							
4L	B1							2556	2706	2856	3006	3156	3306	3456	3606	3756	3906	4056	4206	4356	4506	4656	4806	4956	6456	
4L	B2							2230	2380	2530	2680	2830	2980	3130	3280	3430	3580	3730	3880	4030	4180	4330	4480	4630	6130	
DORMA FTST-G																										
2L	B1	1428	1578	1728	1878	2028	2178	2328	2478	2628	2778	2928	3078	3228	3378	3528	3678	3828								
2L	B2	1330	1480	1630	1780	1930	2080	2230	2380	2530	2680	2830	2980	3130	3280	3430	3580	3730								
4L	B1							2556	2706	2856	3006	3156	3306	3456	3606	3756	3906	4056	4206	4356	4506	4656	4806	4956		
4L	B2							2230	2380	2530	2680	2830	2980	3130	3280	3430	3580	3730	3880	4030	4180	4330	4480	4630		

End of emergency escape width range

This range is technically possible but may not be allowed as emergency escape width

With G-Iso double glazing fine frame profiles

Features

- Elegant all-glass appearance due to slender frame profiles
- High stability and rigidity
- Low k value with double glazing
- Particularly good insulating properties due to interlocking side seals plus top and bottom seals
- Large clear passage width

required or as dictated by leaf weights

System height

$$H = LH + \text{min. } 200 \text{ mm}$$

1 With LM (aluminium) girder, top light and side screens

2 Lintel fixing (not illustrated)

Operator

ES 90 T or ES 90 TE as

 FTST-G-Iso

Determining the leaf size:

Dependent on clear passage height **LH** and clear passage width **LW**. Do not exceed the maximum door leaf weight allowed for the operators (drive units) concerned. For difficult wind conditions adjust size of door.

TST-G-Iso

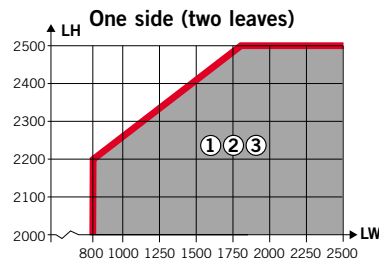

Double glazing

- ① 4/12/4 mm
- ② 5/10/5 mm
- ③ 6/8/6 mm

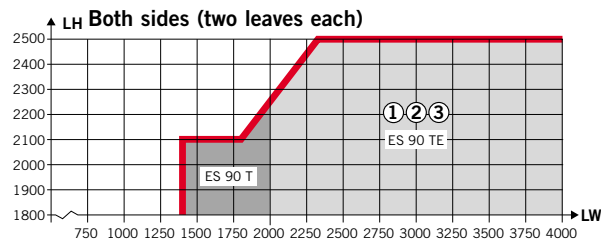

FTST-G-Iso

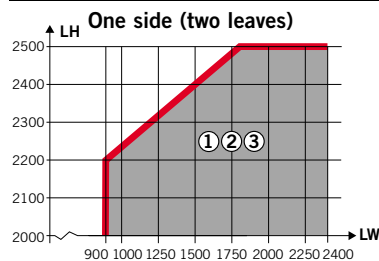

Double glazing

- ① 4/12/4 mm
- ② 5/10/5 mm
- ③ 6/8/6 mm

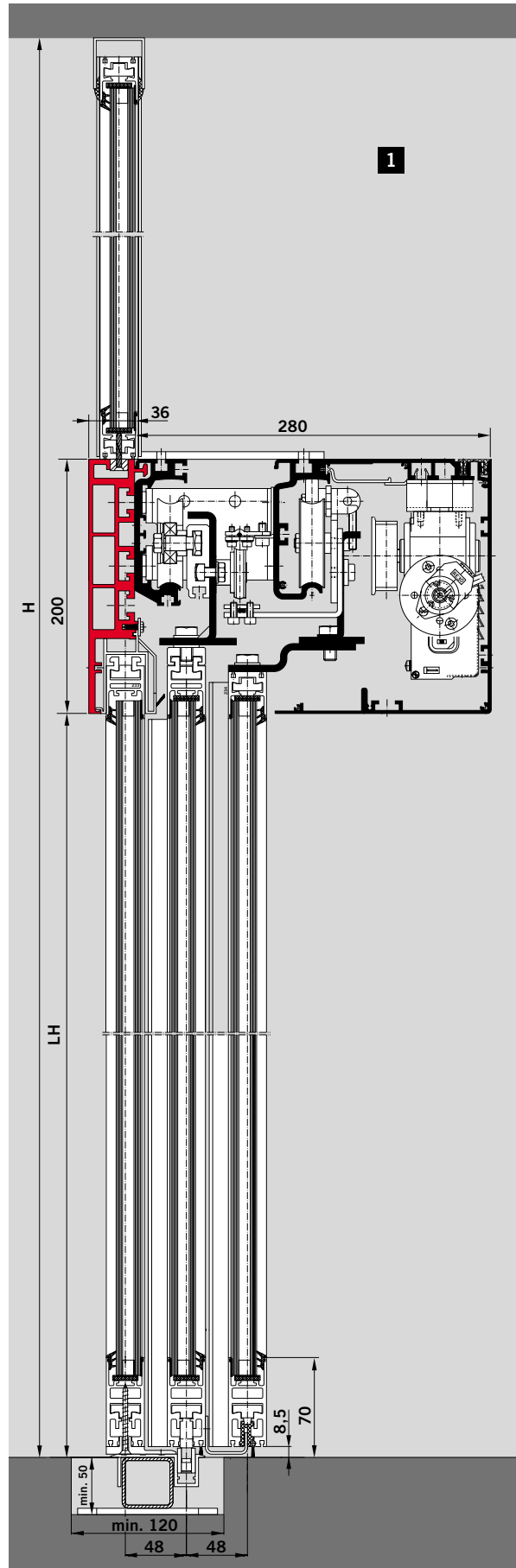
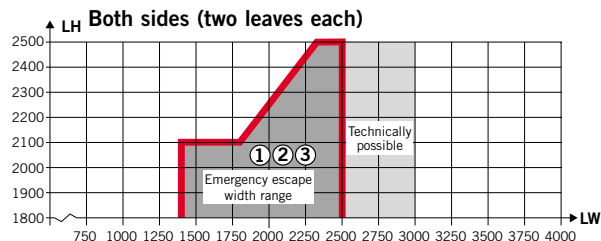

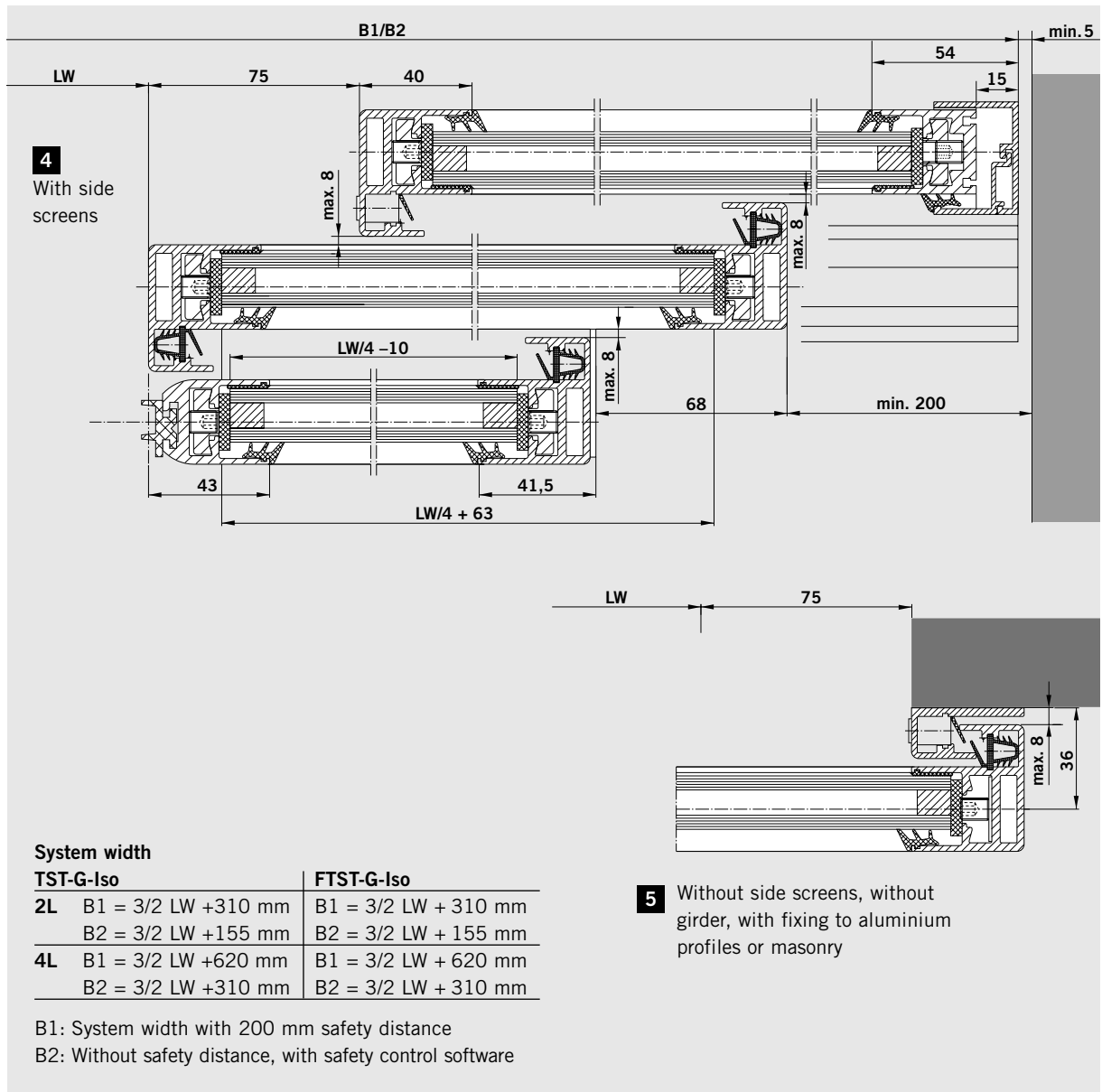

Standard clear passage widths and system widths

Version		1	2	3	4	5	6	7	8	9	10	11	12	13	14	15	16	17	18	19	20	21	22	23	33	
LW		800	900	1000	1100	1200	1300	1400	1500	1600	1700	1800	1900	2000	2100	2200	2300	2400	2500	2600	2700	2800	2900	3000	4000	
DORMA TST-G-Iso																										
2L	B1	1510	1660	1810	1960	2110	2260	2410	2560	2710	2860	3010	3160	3310	3460	3610	3760	3910	4060							
2L	B2	1355	1505	1655	1805	1955	2105	2255	2405	2555	2705	2855	3005	3155	3305	3455	3605	3755	3905							
4L	B1							2720	2870	3020	3170	3320	3470	3620	3770	3920	4070	4220	4370	4520	4670	4820	4970	5120	6620	
4L	B2							2410	2560	2710	2860	3010	3160	3310	3460	3610	3760	3910	4060	4210	4360	4510	4660	4810	6310	
DORMA FTST-G-Iso																										
2L	B1	1510	1660	1810	1960	2110	2260	2410	2560	2710	2860	3010	3160	3310	3460	3610	3760	3910	4060							
2L	B2	1355	1505	1655	1805	1955	2105	2255	2405	2555	2705	2855	3005	3155	3305	3455	3605	3755	3905							
4L	B1							2720	2870	3020	3170	3320	3470	3620	3770	3920	4070	4220	4370	4520	4670	4820	4970	5120		
4L	B2							2410	2560	2710	2860	3010	3160	3310	3460	3610	3760	3910	4060	4210	4360	4510	4660	4810		

End of emergency escape width range

This range is technically possible but may not be allowed as emergency escape width

With R-type standard frame profiles

Features

- Rugged frames which reliably protect the glazing
- High stability and rigidity
- Protection against draughts due to interlocking side seals
- Large clear passage width

Operator

ES 90 T or ES 90 TE as required or as dictated by leaf weights

System height

$$H = LH + \text{min. } 200 \text{ mm}$$

1 With LM (aluminium) girder, top light and side screens, or with MSH steel hollow section girder (not illustrated)

2 Lintel fixing (not illustrated)



Determining the leaf size:

Dependent on clear passage height **LH** and clear passage width **LW**. Do not exceed the maximum door leaf weight allowed for the operators (drive units) concerned. For difficult wind conditions adjust size of door.

TST-R

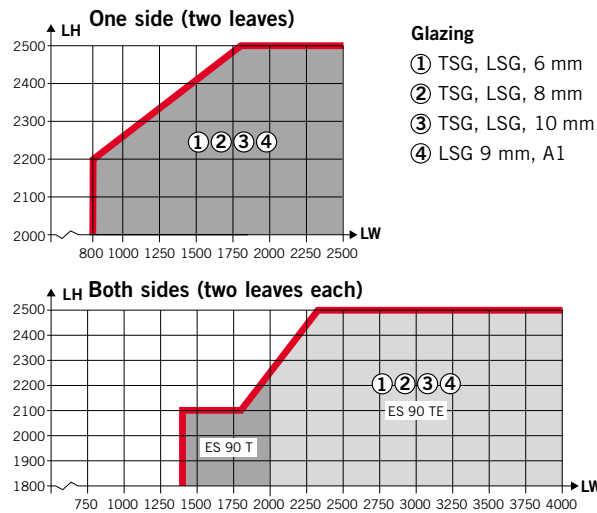

FTST-R

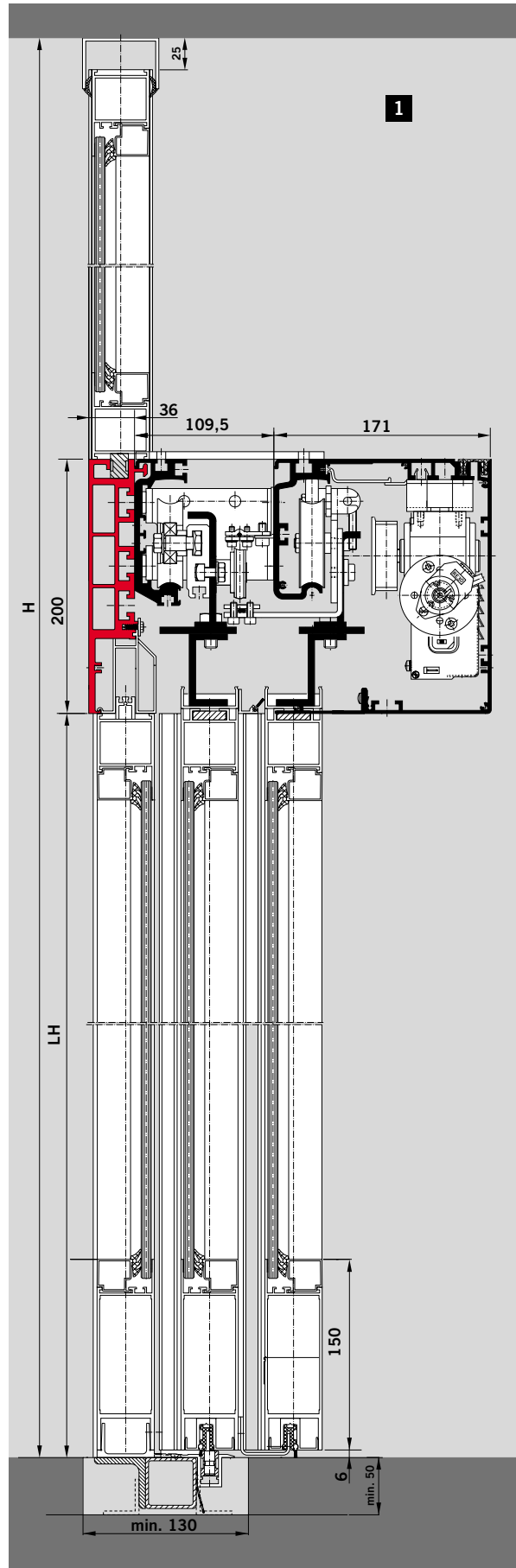
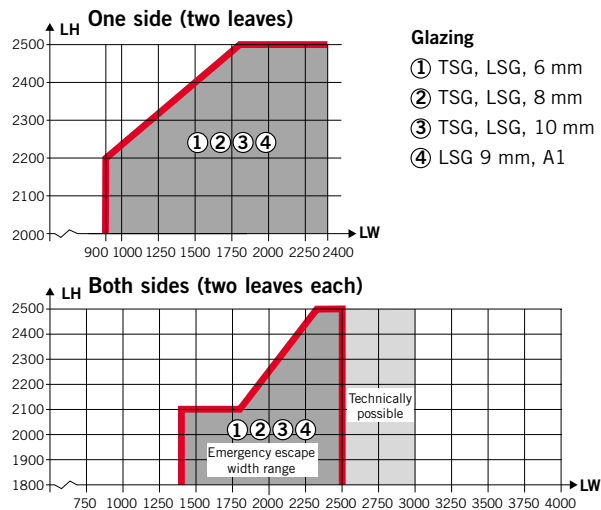

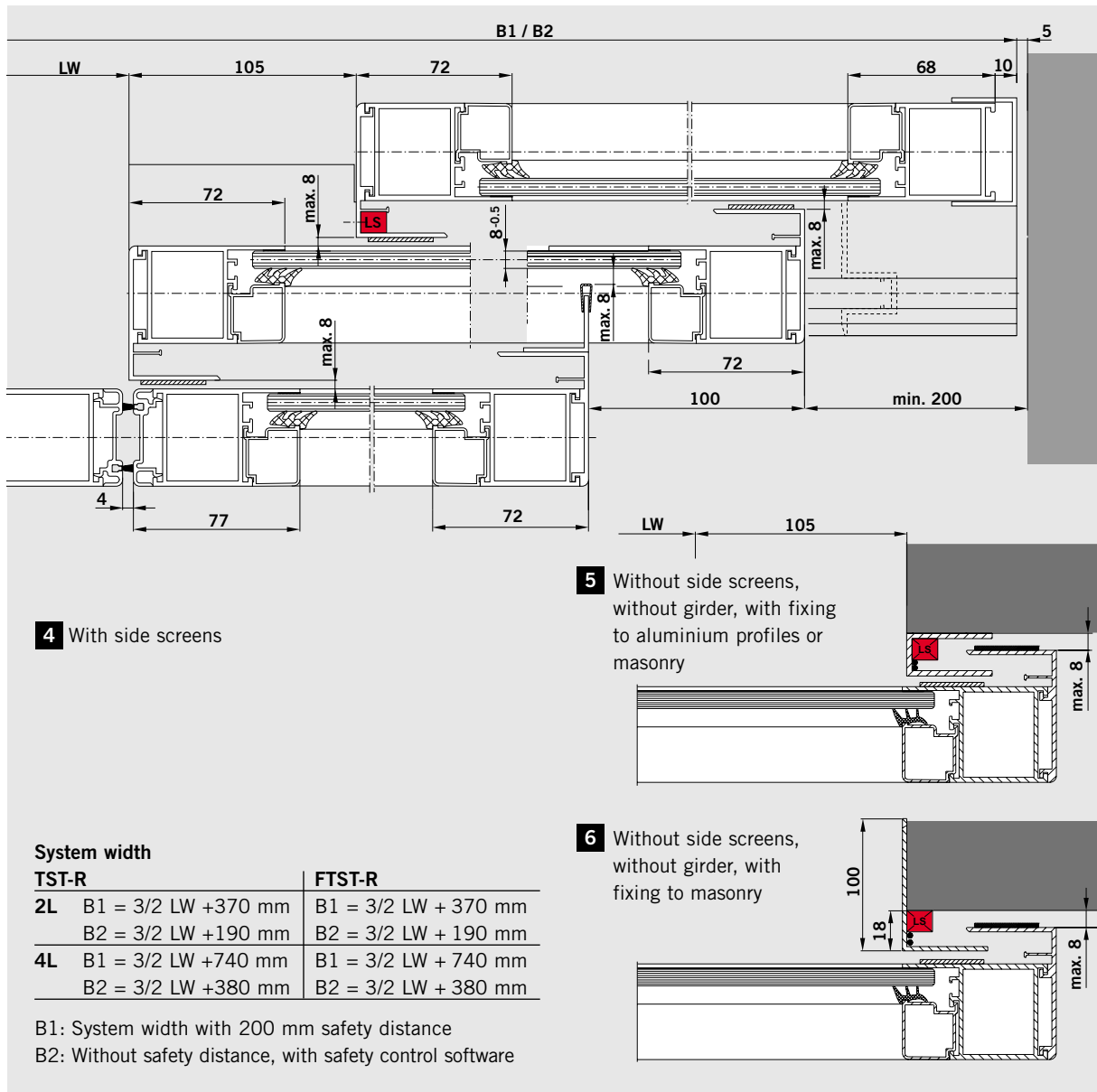

Standard clear passage widths and system widths

Version		1	2	3	4	5	6	7	8	9	10	11	12	13	14	15	16	17	18	19	20	21	22	23	33	
LW		800	900	1000	1100	1200	1300	1400	1500	1600	1700	1800	1900	2000	2100	2200	2300	2400	2500	2600	2700	2800	2900	3000	4000	
DORMA TST-R																										
2L	B1	1570	1720	1870	2020	2170	2320	2470	2620	2770	2920	3070	3220	3370	3520	3670	3820	3970	4120							
2L	B2	1390	1540	1690	1840	1990	2140	2290	2440	2590	2740	2890	3040	3190	3340	3490	3640	3790	3940							
4L	B1							2840	2990	3140	3290	3440	3590	3740	3890	4040	4190	4340	4490	4640	4790	4940	5090	5240	6740	
4L	B2							2480	2630	2780	2930	3080	3230	3380	3530	3680	3830	3980	4130	4280	4430	4580	4730	4880	6380	
DORMA FTST-R																										
2L	B1	1570	1720	1870	2020	2170	2320	2470	2620	2770	2920	3070	3220	3370	3520	3670	3820	3970								
2L	B2	1390	1540	1690	1840	1990	2140	2290	2440	2590	2740	2890	3040	3190	3340	3490	3640	3790								
4L	B1							2840	2990	3140	3290	3440	3590	3740	3890	4040	4190	4340	4490	4640	4790	4940	5090	5240		
4L	B2							2480	2630	2780	2930	3080	3230	3380	3530	3680	3830	3980	4130	4280	4430	4580	4730	4880		

End of emergency escape width range → ← This range is technically possible but may not be allowed as emergency escape width

High stability plus optimum protection

In their double leaf version, DORMA sliding door systems of the ST/ES design with R-type standard frame profiles or with G-Iso fine frame profiles for double glazing come with the option of an automatic concealed-rod locking system. The locking rods of high-strength steel are integrated out of sight in the centre seal profiles.

In the locked condition, the rods extend to engage both in high-strength keeps located in the transom construction and in bushing-type keeps recessed in the floor. This four-point locking system ensures maximum resistance against all attempts to force the sliding panels open.

The locking and unlocking operations are performed by means of an electric motor integrated in the transom assembly.

In the event of a power failure or in emergency situations, the sliding leaves can be manually locked and unlocked by means of a lever mechanism. The locking system can only be unlocked from the outside by an authorised opening signal. The system can be equipped with an audible or visual locking indicator triggered via a floating contact. The bushing-type keeps recessed in the floor are provided with spring-loaded covers to protect them

against dirt and contamination when the door is unlocked, and are easy to clean.

For emergency exits and escape routes

A model suitable for employment in emergency escape routes is also available.

DORMA ST-R/ES with concealed-rod multipoint locking system

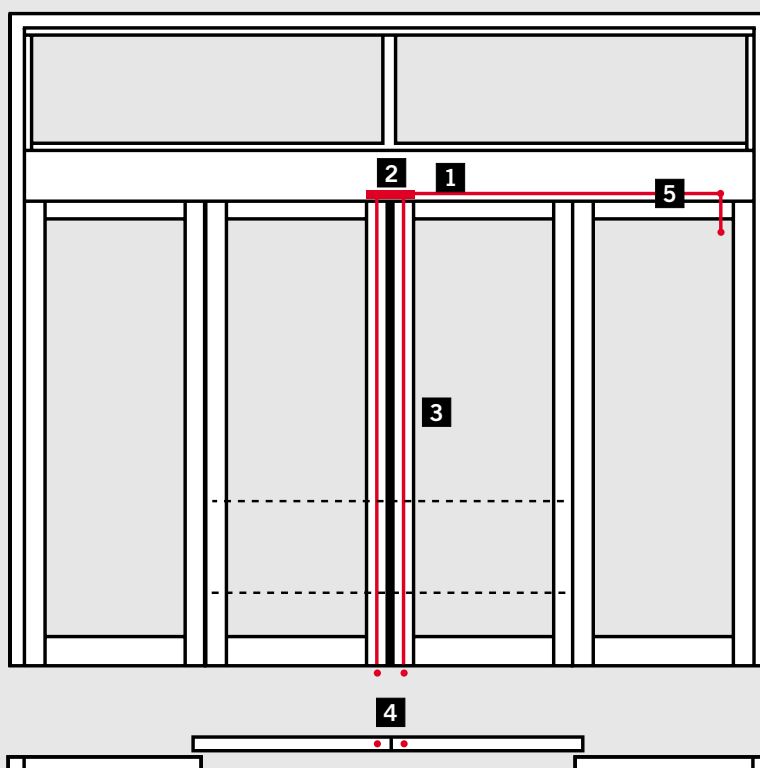

ST-G-Iso/ES with concealed-rod locking system

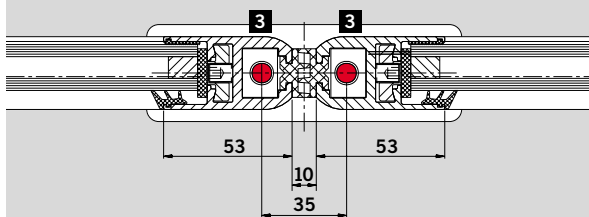
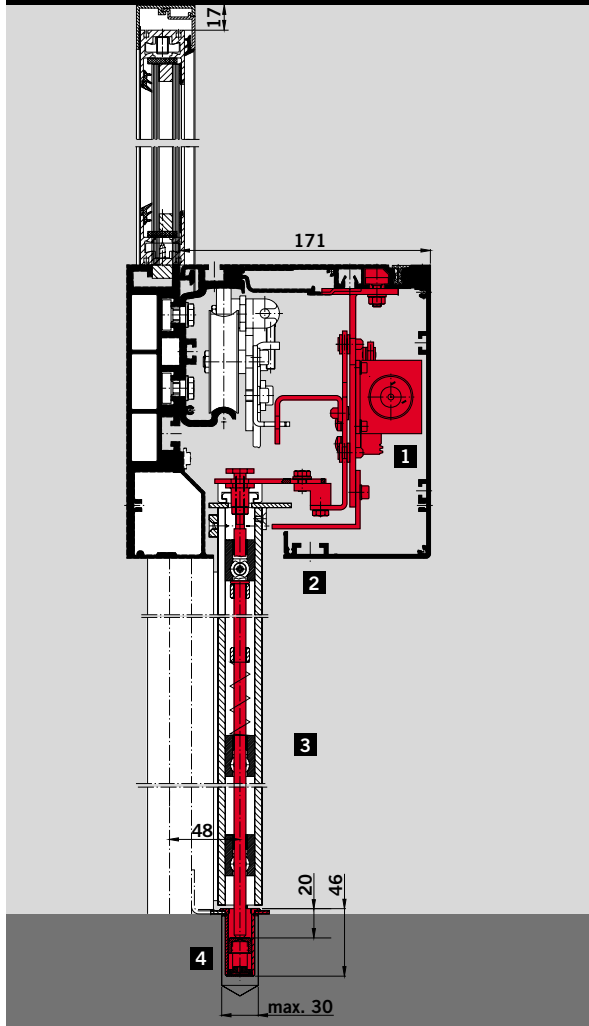

- 1** Electric drive unit for locking and unlocking
- 2** Top keep
- 3** Concealed locking rods
- 4** Floor keep
- 5** Manual unlocking device

ST-R/ES with concealed-rod locking system

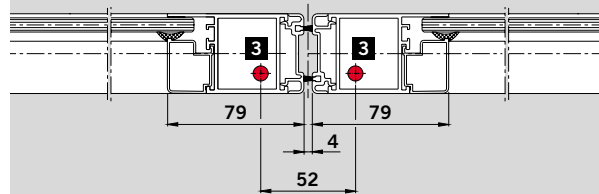
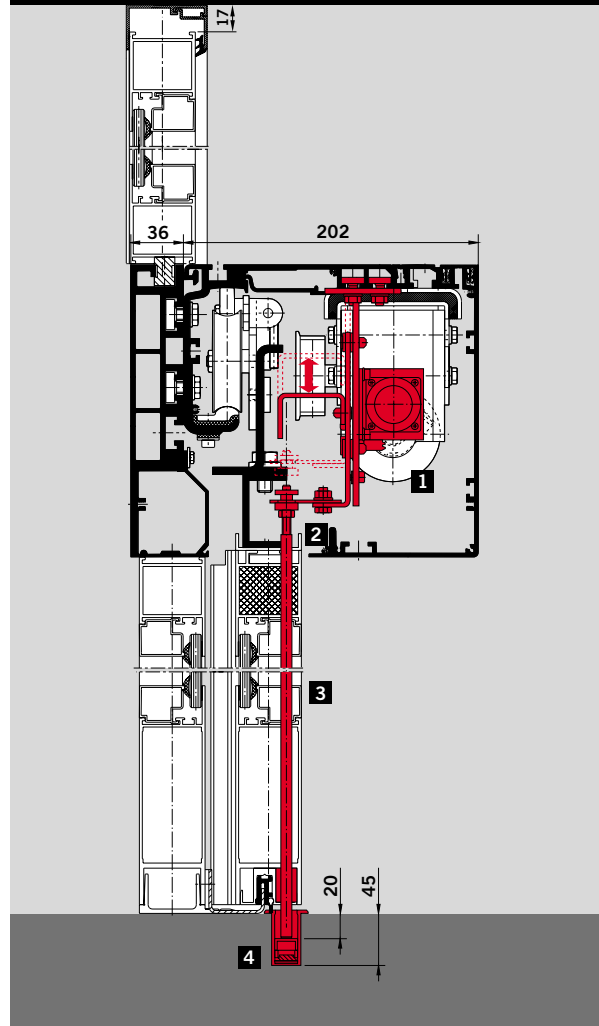

- 1** Electric drive unit for locking and unlocking
- 2** Top keep
- 3** Concealed locking rods
- 4** Floor keep
- 5** Manual unlocking device

Features and benefits

- High level of security protection
- Solves the age-old contradiction: Locked against ingress, but openable from the inside
- No impairment to the visual attractiveness of the door
- Designed and manufactured in accordance with the latest state of the art and in line with all relevant standards and specifications.



FST-R/ES with concealed-rod multipoint locking system – Connections

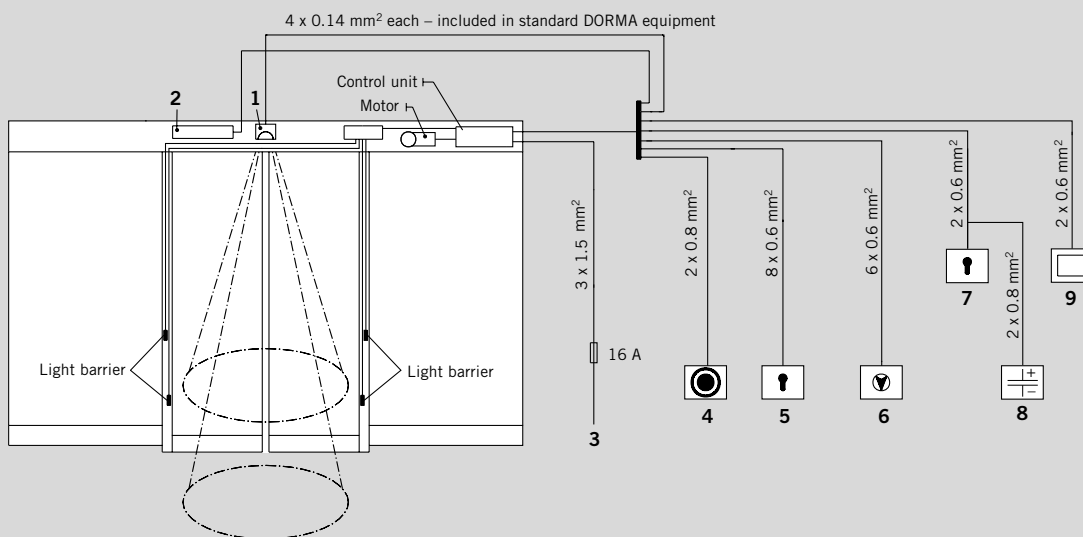

- | | |
|--|--|
| <p>1 Motion detector – internal, external</p> <p>2 Locking system</p> <p>3 Power supply: 230 V, 50/60 Hz
(Illustration shows FST/ES model with cable lead-in from the right; ST/ES model: cable lead-in from the left)</p> <p>4 Emergency stop pushbutton to be installed next to door; cable length max. 100 m. Recommended height of installation 0.98 – 1.05 m.</p> | <p>5 Key switch for activating the locking system (only FST/ES where used in emergency exits and escape routes)</p> <p>6 Program switch, cable length max. 100 m; where installed with other lines, provide with shield</p> <p>7 Key switch, code card reader with floating contact or similar, external</p> <p>8 Blind cable for external power supply 24 V DC</p> <p>9 Pushbutton, internal</p> |
|--|--|

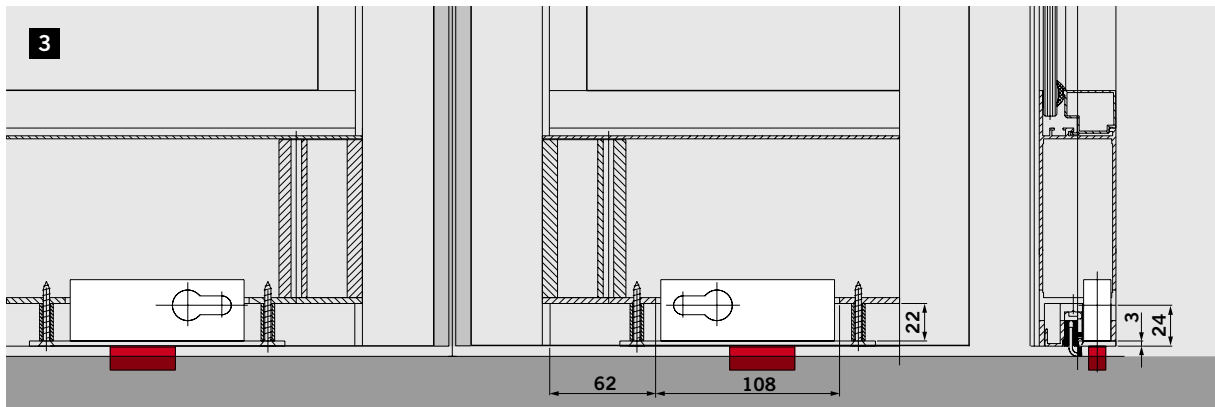
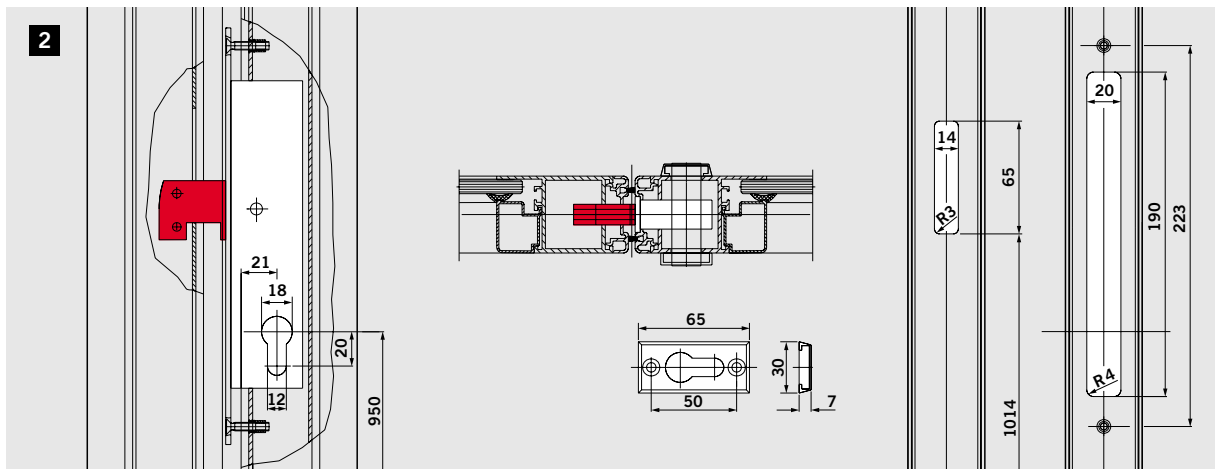
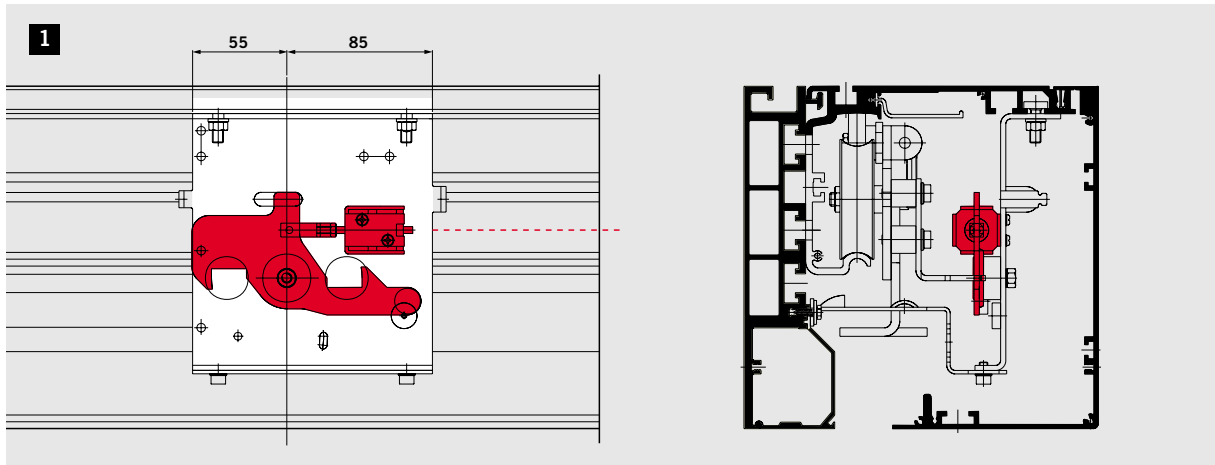

Lock options

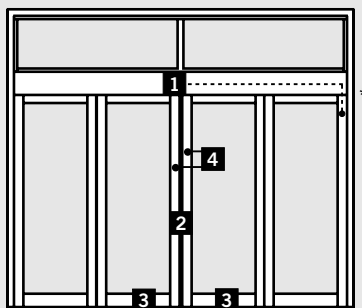

1 In-transom electro-mechanical dual-action hook lock; with manual unlocking for FST/ES and FTST/ES (not illustrated)

2 Hook lock; for ST-R/ES, FST-R/ES and TST-R, FTST-R sliding doors only

3 Floor locks

4 Automatic concealed-rod multipoint locking system; for ST-R/ES, FST-R/ES, ST-G-Iso/ES and FST-G-Iso/ES sliding doors only (see pages 20 – 22)

Operator types



- Components** (Illustration shows ES 90/ES 100)
- 1 Track and mounting profile
 - 2 Carrier
 - 3 Door suspension device with adjustable fixture
 - 4 Motor with decoder
 - 5 Track rail
 - 6 Return pulley
 - 7 Basic module, control with integrated switched power supply unit and multi-way connectors for optional expansion modules
 - 8 Door stop

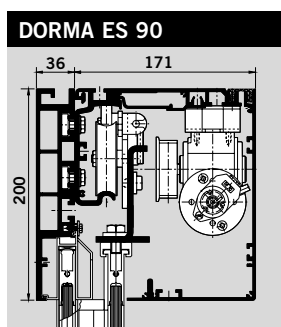

1 Standard operator with low-noise track rail

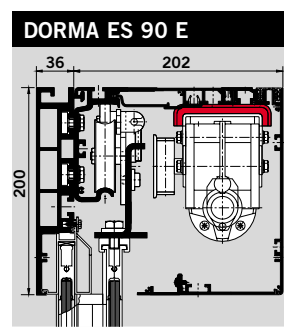

2 Standard operator with low-noise track rail, sound-insulated motor mounting and increased motor capacity

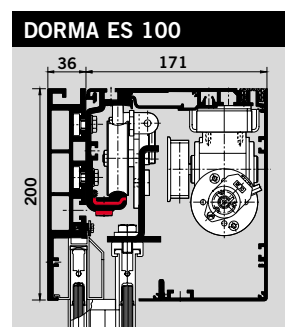

3 Enhanced operator with low-noise, replaceable track rail

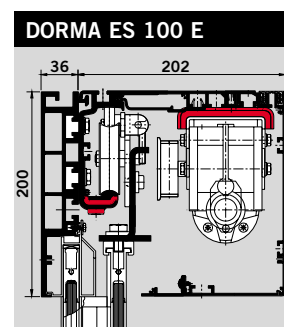

4 Enhanced operator with sound-insulated motor mounting, low-noise, replaceable track rail and increased motor capacity

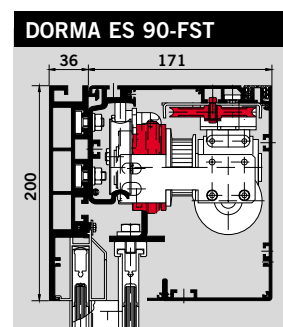

5 Standard operator with low-noise track rail

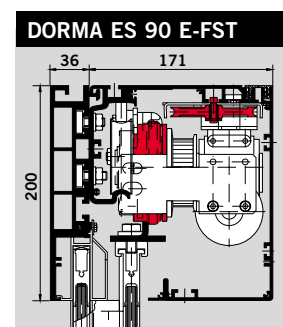

6 Standard operator with low-noise track rail, sound-insulated motor mounting and increased motor capacity

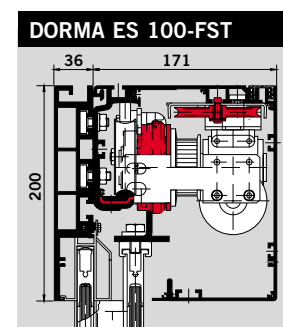

7 Enhanced operator with low-noise, replaceable track rail

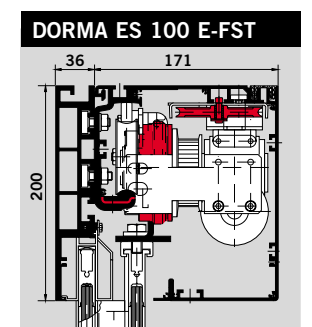

8 Enhanced operator with sound-insulated motor mounting, low-noise, replaceable track rail and increased motor capacity

FST operators for sliding doors in emergency exits and escape routes

Additional equipment

- Expansion module EM5
- Self-monitoring functions for all main components
- Electro-magnetic clutch
- Rubber rope as redundant energy source
- Self-monitoring radar motion detector in the escape direction

CP 90 program selector



- Program selection
- Indication of the current program
- Adjustment of basic parameters
- CP 90 C with timer function
- CP 90 N for night-bank mode (additional to CP 90 or CP 90 C)
- Display of error codes for remote diagnostics
- Available in black, white and silver
- Dimensions (W x H) 48 mm x 125 mm
- Suitable for ST/ES and TST

Program switches



- External installation
- Concealed or surface-mounted units
- Lockable/Rotary knob
- Suitable for standard flush-type boxes
- Can be integrated with an emergency-stop switch in a double frame
- Key switches concealed or surface-mounted

Radar motion detectors



- Eagle system
- Directionally sensitive or standard model
- Any combination of radar heads
- No official licence fees (in most countries)
- No effect on pacemakers with a very low output of just approx. 2 mW
- No interference from mobile phones

Switches/Pushbuttons



- Concealed and surface-mounted
- Stainless steel finishes
- Water-resistant models
- Keypads for access control systems

Hand terminal



- Fast and problem-free commissioning of DORMA sliding doors
- Adjustment of basic parameters
- Simple and reliable diagnostics in the event of malfunctions
- Plain text display

Door frame profiles

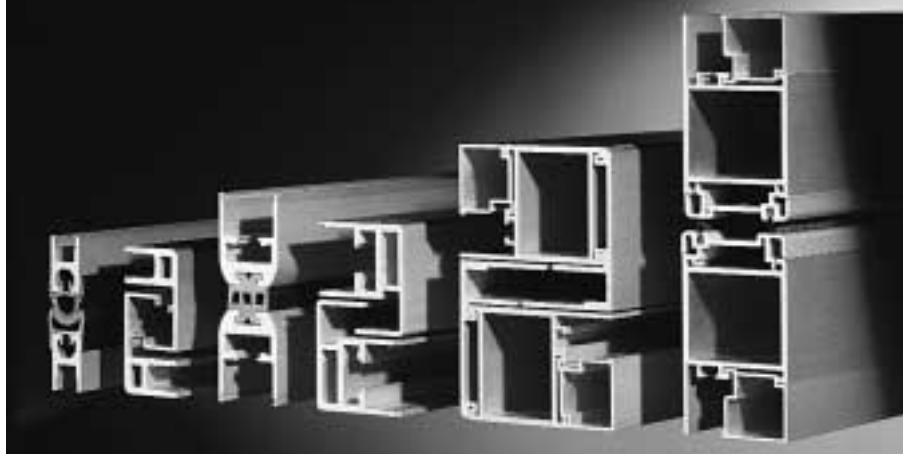

Fine frame safety glass profile system
DORMA ST-G, FST-G, TST-G, FTST-G

Fine frame double glazing profile system
DORMA ST-G-Iso, FST-G-Iso, TST-G-Iso, FTST-G-Iso

Standard frame profile system
DORMA ST-R, FST-R, TST-R, FTST-R

Thermal break profile system
ST-R-Thermo, FST-R-Thermo (not illustrated)

Specification text

Automatic telescopic sliding door system with

- 4 sliding leaves (standard) 2 sliding leaves
 2 side screens 1 side screen
 without side screens
 with safety control software
 Top light
 1-piece 2-piece 3-piece
 Solid top panel
 FTST approved for emergency exits and escape routes

Manufactured in accordance with German guidelines for power-operated windows, doors and gates, ZH 1/494, German UVV (accident prevention) regulations and VDE (German Association of Electrical Engineers) standards, latest edition in each case. Type-approved by the German Technical Inspectorate (TÜV); tested and approved in accordance with EU low-voltage directives; manufactured on the basis of a quality management system registered to ISO 9000.

Power supply: 230 V, 50/60 Hz

Design:

- Fine frame (toughened glass) profiles, G
 Double glazing fine frame profiles, G-Iso
 Standard frame profiles, R

Transom construction:

- LM (aluminium) girder, self-supporting up to 4000 mm
 LM (aluminium) girder, side screen supported, up to 6600 mm, including cover
 MSH girder (non-standard)

Installation:

- Corridor (passage) Wall (face-fix)

Floor guide:

- Floor surface guide without floor track (standard)
 Concealed guide with floor track

Sliding leaf glazing:

- Toughened safety glass (TSG)... Laminated safety glass (LSG)...
 Double glazing ... Special glass
 Adhesive-bonded midrails

Side screen glazing:

- Toughened safety glass (TSG)... Laminated safety glass (LSG)...
 Double glazing ... Special glass
 Adhesive-bonded midrails

Top light glazing:

- Float glass ... Toughened safety glass (TSG) ...
 Laminated safety glass (LSG)... Double glazing ...
 Special glass

Operator drive and control unit, TST:

Automatic sliding door operator of modular design
 ES 90 T ES 90 TE

Integrated microprocessor control, self-learning, with adjustable parameters for opening and closing speed, hold-open time and also opening and closing force. With pulse expansion for cheque card/code card reader or key switch. With RS 485 interface, connection for access control system, bell contact and battery pack. Degree of protection IP 20.

- Fail-safe (standard) [opens when de-energised]
 Fail-secure [closes when de-energised]
 Connection for airlock control
 Door status signal
 Module for connection to EIB building control system
 Emergency power module (UPS)

Operator drive and control unit, FTST:

Automatic sliding door operator of modular design
 ES 90 T-FST ES 90 TE-FST

With self-diagnostics of the microprocessor control and integrated EM5 expansion module for redundant monitoring of opening safety. Self-learning, with adjustable parameters for opening and closing speed, hold-open time and also opening and closing force. Fail-safe (opens when de-energised). With pulse expansion for cheque card/code card reader or key switch. With RS 485 interface, connection for access control system, bell contact and battery pack. Degree of protection IP 20.

- Door status signal
 Module for connection to EIB building control system
 Emergency power module (UPS)

Function programs:

Off; Automatic; Permanent open; Partial opening; Exit only; Self-regulating partial opening; Exit only, partial opening; Night-bank control

Safety devices:

Automatic obstruction detection; automatic reversing cycle; force limitation; emergency stop pushbutton; integrated safety light barriers for presence monitoring

Switches, pushbuttons, external:

- Program switch
 lockable (FTST) non-lockable (not for FTST)
 concealed surface-mounted
 Emergency stop pushbutton, external:
 lockable non-lockable
 concealed surface-mounted with emergency break glass
 Electronic program selector, surface-mounted (TST only)
 CP 90 CP 90 C (with timer function)
 CP 90 N (for night-bank control, additional to CP 90 or CP 90 C)

Locking system:

- Electro-mechanical lock, including manual unlocking
 Mechanical lock

Activators:

- Eagle 1 radar motion detector, directionally sensitive, ... units
 Eagle 2 radar motion detector, non-directionally sensitive, ... units
 Eagle 3 radar motion detector, self-monitoring, ... units (for FST/ES)
 Other:, units

Finish for aluminium parts:

- silver anodised (Eloxal EV6/CO)
 dark-brown anodised (Eloxal EV6/C34)
 RAL Special colour

System dimensions:

Total width B mm Clear passage width LW mm
 Total height H mm Clear passage height LH mm

Make:

- DORMA TST
 DORMA FTST

Specification text**Automatic sliding door with**

- 2 sliding leaves (standard) 1 sliding leaf
 2 side screens 1 side screen
 without side screens
 2 hinged safety pocket screens 1 hinged safety pocket screen
 with safety control software (without hinged safety pocket screens)
 Top light
 1-piece 2-piece 3-piece
 Solid top panel
 FST/ES approved for emergency exits and escape routes

Manufactured in accordance with German guidelines for power-operated windows, doors and gates, ZH 1/494, German UVV (accident prevention) regulations and VDE (German Association of Electrical Engineers) standards, latest edition in each case. Type-approved by the German Technical Inspectorate (TÜV); tested and approved in accordance with EU low-voltage directives; manufactured on the basis of a quality management system registered to ISO 9000.

Power supply: 230 V, 50/60 Hz

Design:

- Fine frame (toughened glass) profiles, G
 Fine frame double glazing profiles, G-Iso
 Standard frame profiles, R Thermal break profiles, R-Thermo

Transom construction:

- LM (aluminium) girder, self-supporting up to 4000 mm
 LM (aluminium) girder, side screen supported, up to 6600 mm, including cover
 MSH girder (non-standard)

Installation:

- Corridor (passage) Wall (face-fix)

Floor guide:

- Floor surface guide without floor track (standard)
 Concealed guide with floor track

Sliding leaf glazing:

- Toughened safety glass (TSG)... Laminated safety glass (LSG)...
 Double glazing ... Special glass
 Adhesive-bonded midrails

Side screen glazing:

- Toughened safety glass (TSG)... Laminated safety glass (LSG)...
 Double glazing ... Special glass
 Adhesive-bonded midrails

Hinged safety pocket screen glazing

- Toughened safety glass (TSG)... Laminated safety glass (LSG)...
 Double glazing ... Special glass
 Adhesive-bonded midrails

Top light glazing:

- Float glass ... Toughened safety glass (TSG)...
 Laminated safety glass (LSG)... Double glazing
 Special glass

Operator drive and control unit, ST/ES:

Automatic sliding door operator of modular design

- ES 90 ES 90 E
 ES 100 ES 100 E

Integrated microprocessor control, self-learning, with adjustable parameters for opening and closing speed, hold-open time and also opening and closing force. With pulse expansion for cheque card/code card reader or key switch. With RS 485 interface, connection for access control system, bell contact and battery pack. Degree of protection IP 20.

- Fail-safe (standard) [opens when de-energised]
 Fail-secure [closes when de-energised]
 Connection for airlock control
 Door status signal
 Module for connection to EIB building control system
 Emergency power module (UPS)

Operator drive and control unit, FST/ES:

Automatic sliding door operator of modular design

- ES 90-FST ES 90 E-FST
 ES 100-FST ES 100 E-FST

With self-diagnostics of the microprocessor control and integrated EM5 expansion module for redundant monitoring of opening safety, plus redundant power source. Self-learning, with adjustable parameters for opening and closing speed, hold-open time and also opening and closing force. Fail-safe (opens when de-energised). With pulse expansion for cheque card/code card reader or key switch. With RS 485 interface, connection for access control system, bell contact and battery pack. Degree of protection IP 20.

- Door status signal
 Module for connection to EIB building control system
 Emergency power module (UPS)

Function programs:

Off; Automatic; Permanent open; Partial opening; Exit only; Self-regulating partial opening; Exit only, partial opening; Night-bank control

Safety devices:

Automatic obstruction detection; automatic reversing cycle; force limitation; emergency stop pushbutton; integrated safety light barriers for presence monitoring

Switches, pushbuttons, external:

Program switch

- lockable (FST/ES) non-lockable (not for FST/ES)
 concealed surface-mounted

Emergency stop pushbutton, external:

- lockable non-lockable
 concealed surface-mounted with emergency break glass
 Electronic program selector, surface-mounted (ST/ES only)
 CP 90 CP 90 C (with timer function)
 CP 90 N (for night-bank control, additional to CP 90 or CP 90 C)

Locking system:

- Electro-mechanical lock, including manual unlocking
 Mechanical lock (not FST/ES)
 Automatic concealed-rod multipoint locking

Activators:

- Eagle 1 radar motion detector, directionally sensitive, ... units
 Eagle 2 radar motion detector, non-directionally sensitive, ... units
 Eagle 3 radar motion detector, self-monitoring, ... units (for FST/ES)
 Other:, units

Finish for aluminium parts:

- silver anodised (Eloxal EV6/CO)
 dark-brown anodised (Eloxal EV6/C34)
 RAL Special colour

System dimensions:

Total width B mm Clear passage width LW mm
Total height H mm Clear passage height LH mm

Make:

- DORMA ST/ES
 DORMA FST/ES

Subject to change without notice

DORMA GmbH + Co. KG

P.O. Box 4009
58247 Ennepetal
Germany
Tel. +49(0)23 33/793-0
Fax +49(0)23 33/79 34 95
www.dorma.com